

**Color the pictures that begin with the
sound of the letter A**

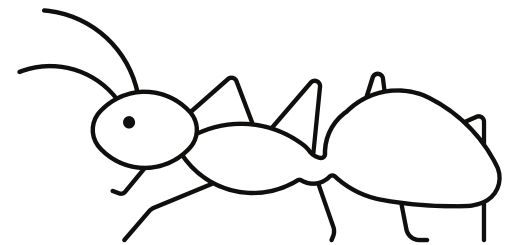

**Color the pictures that begin with the
sound of the letter B**

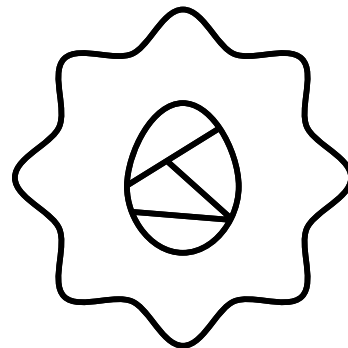
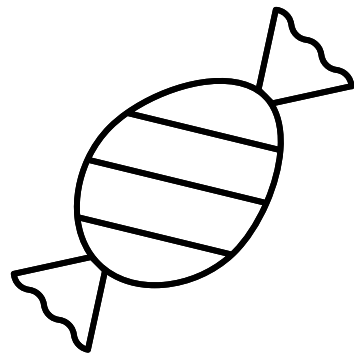
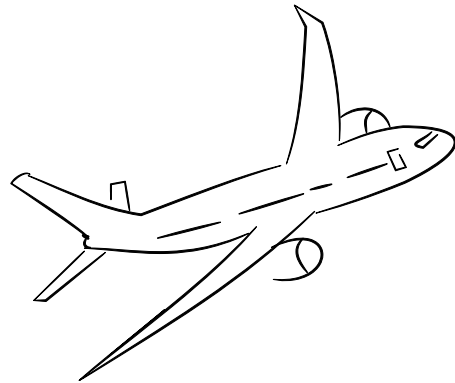
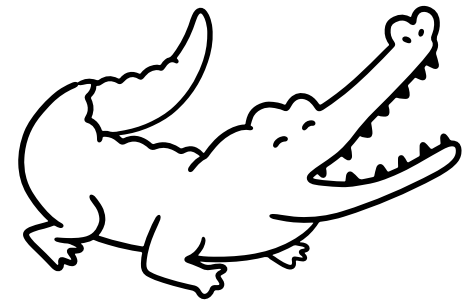
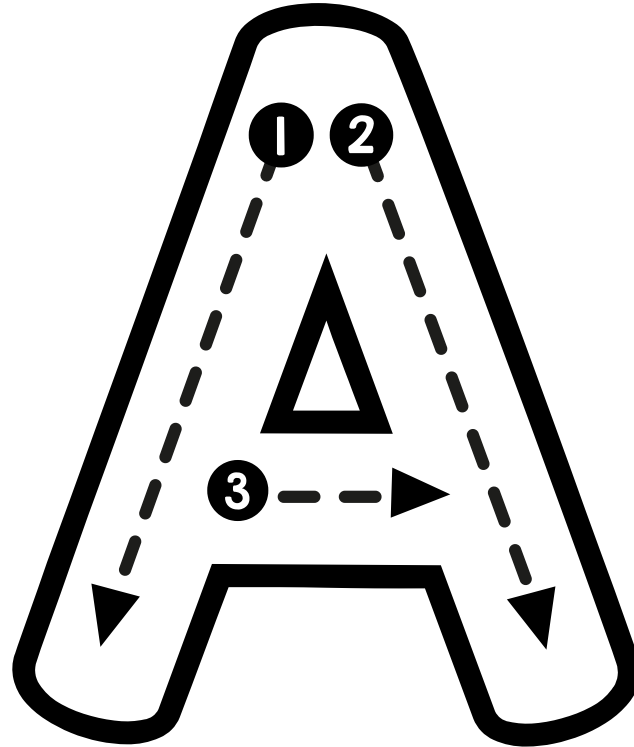
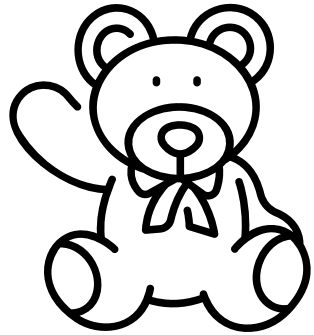
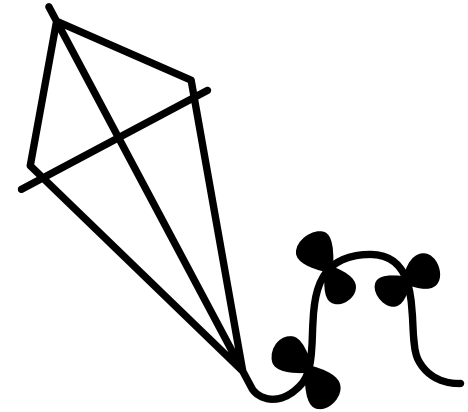
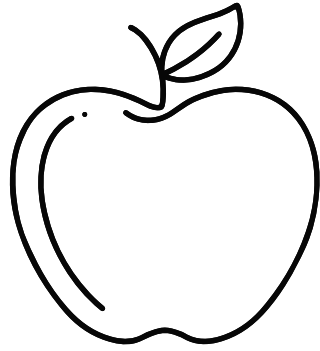
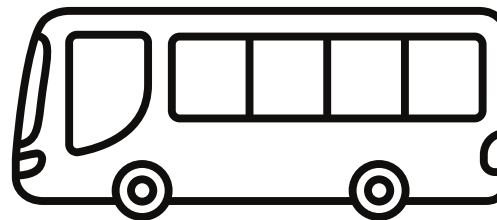
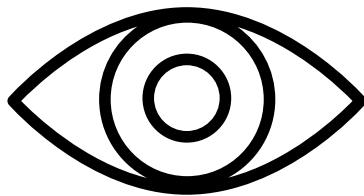
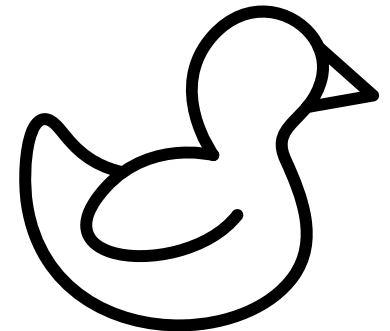
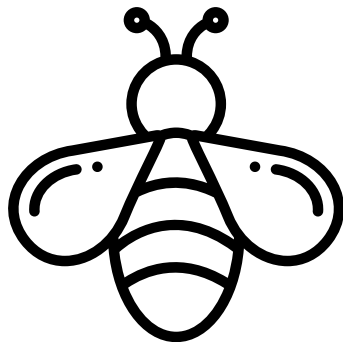
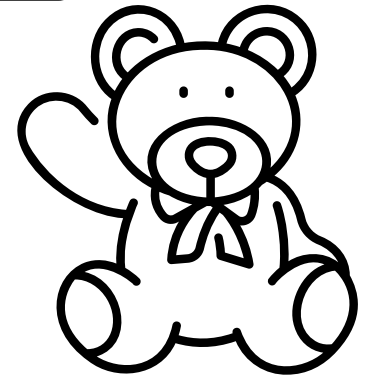
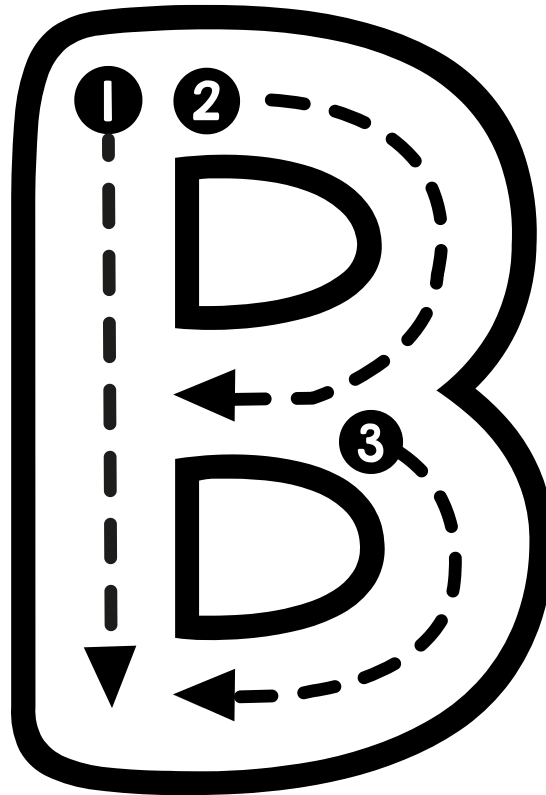
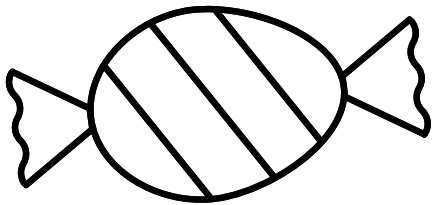
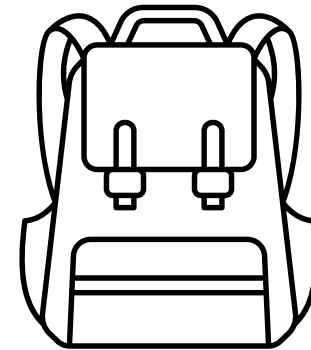
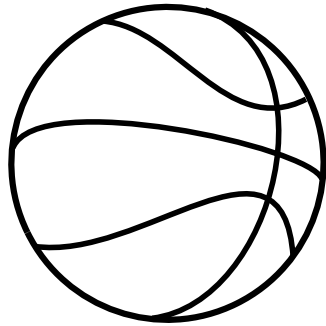

**Color the pictures that begin with the
sound of the letter C**

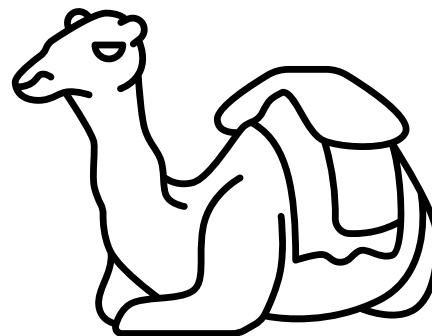
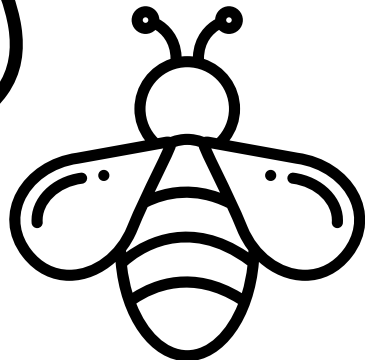
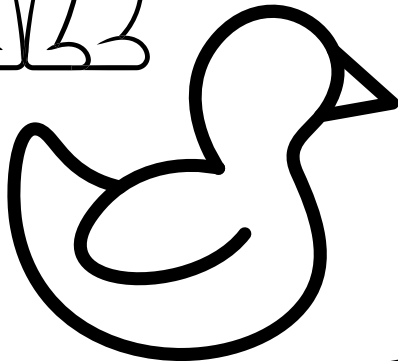
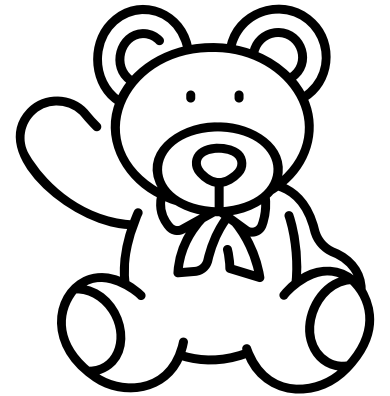
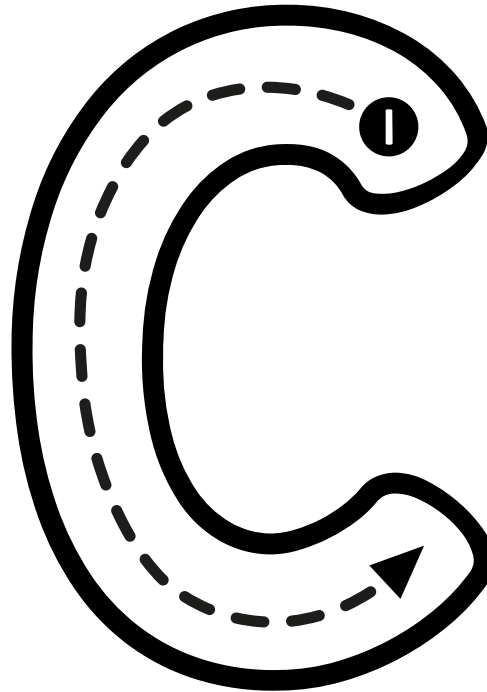
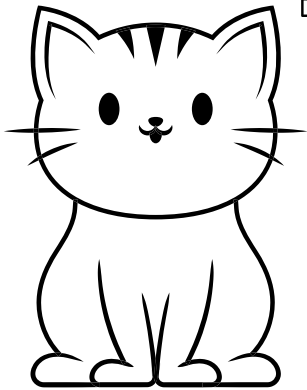
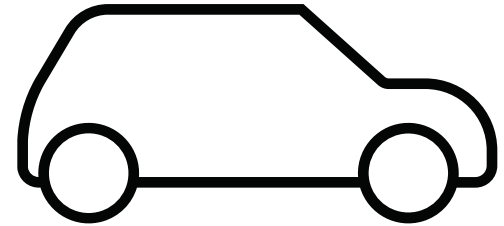
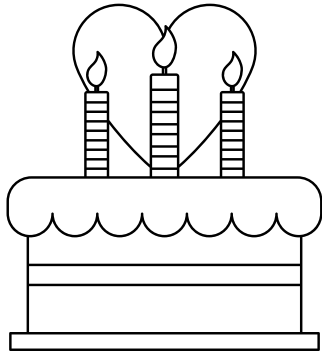

Color the pictures that begin with the
sound of the letter D

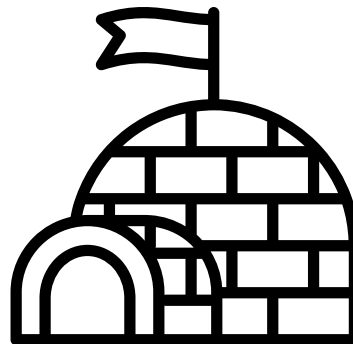
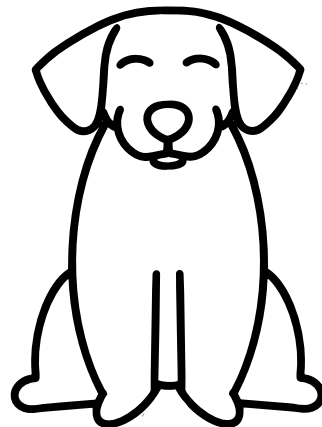
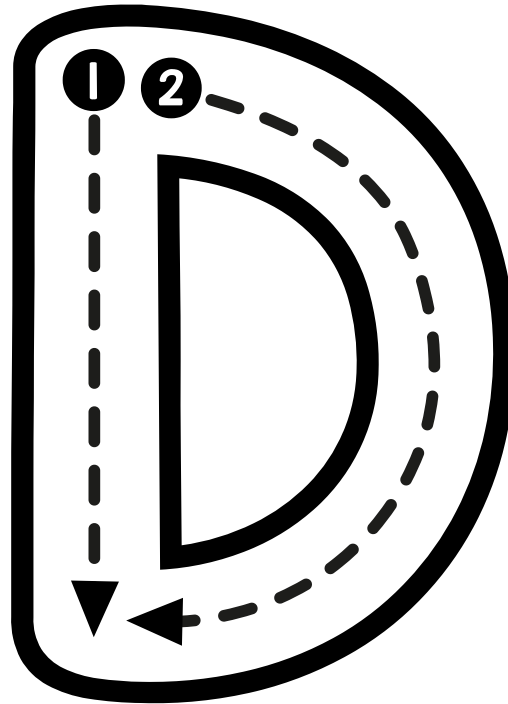
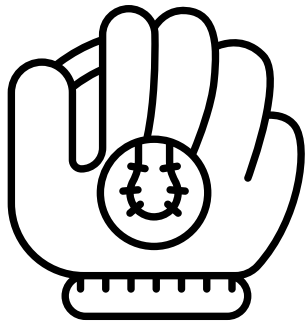
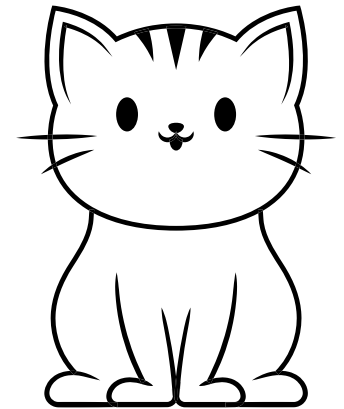
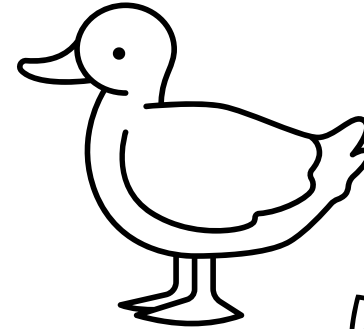
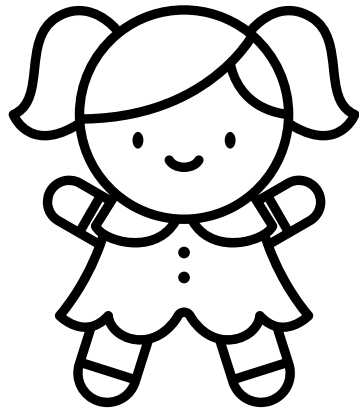

**Color the pictures that begin with the
sound of the letter E**

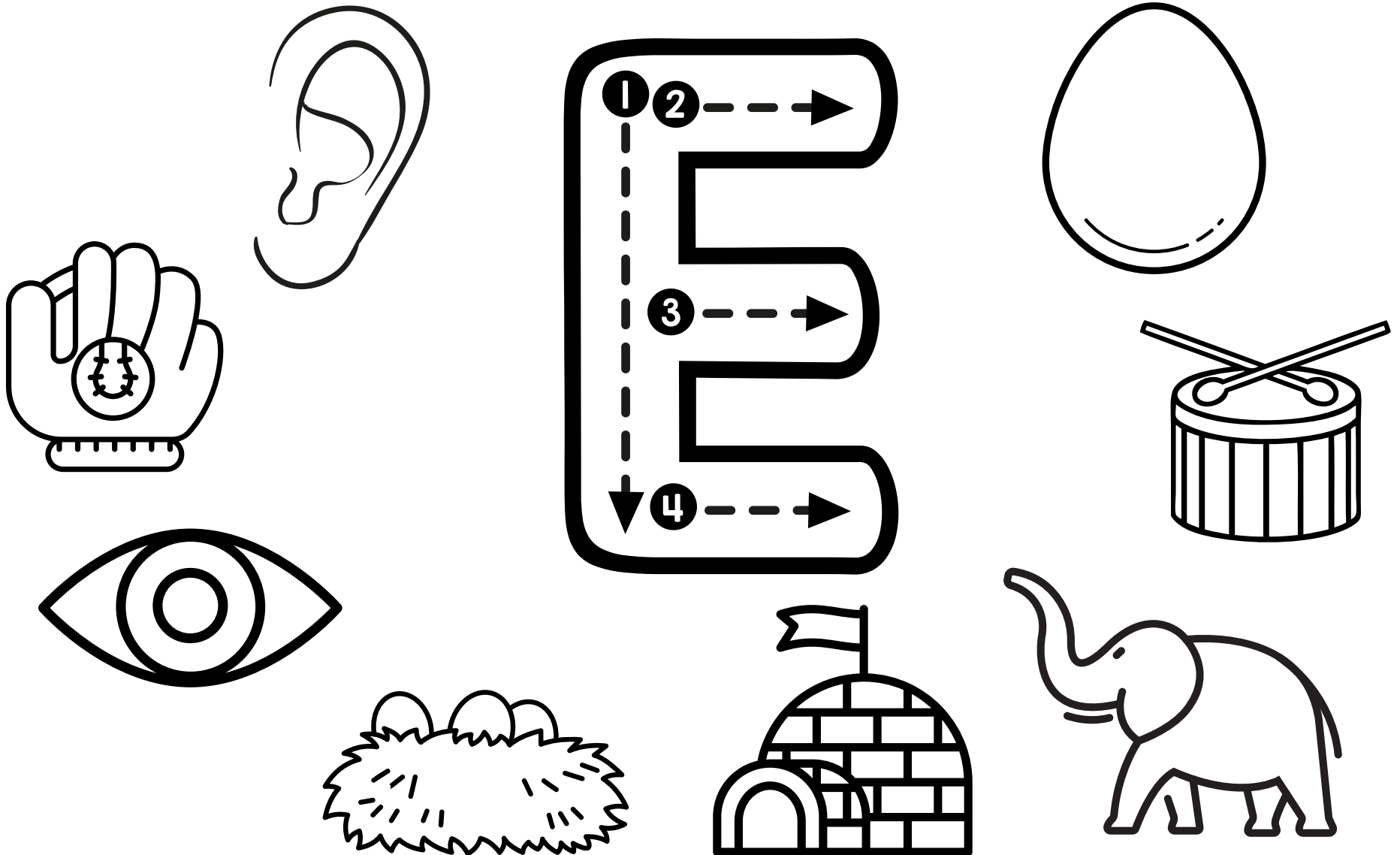

Color the pictures that begin with the
sound of the letter F

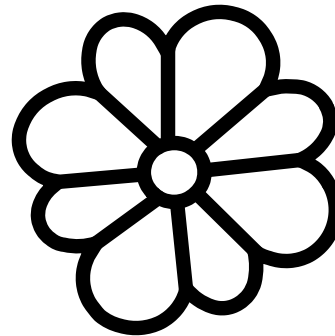
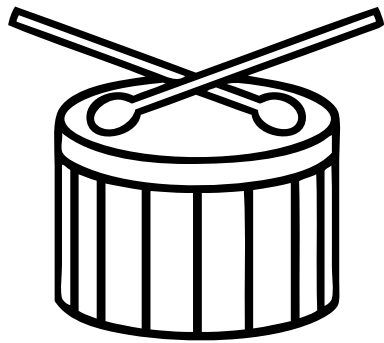
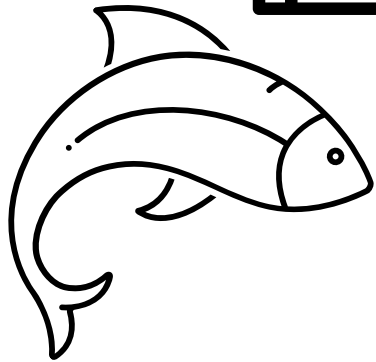
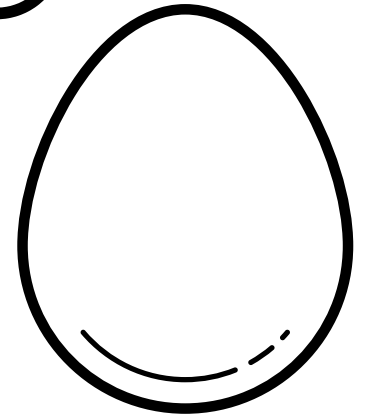
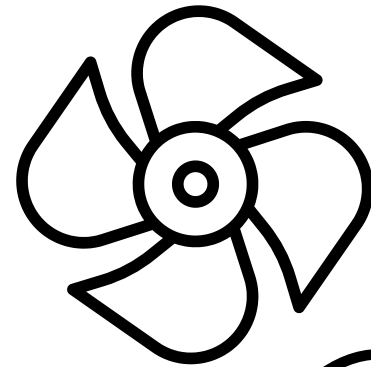
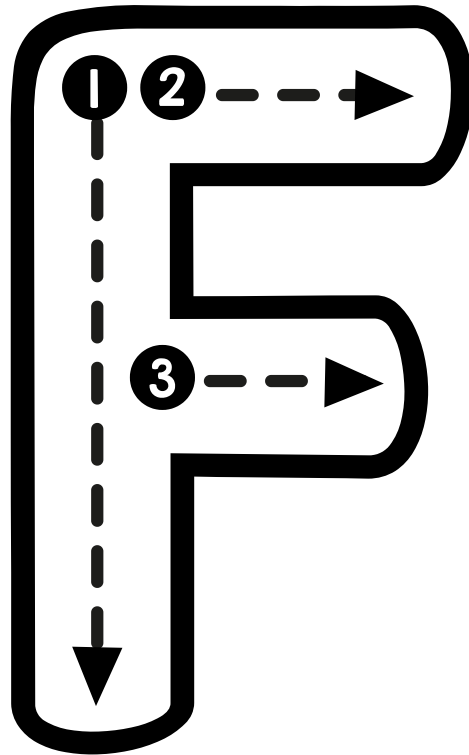
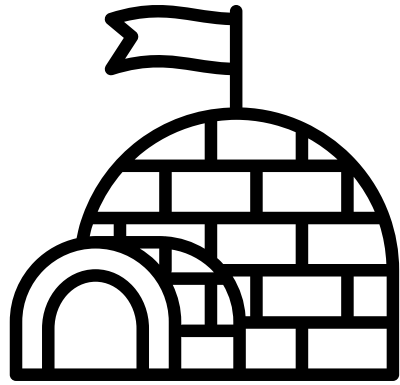

**Color the pictures that begin with the
sound of the letter G**



**Color the pictures that begin with the
sound of the letter H**

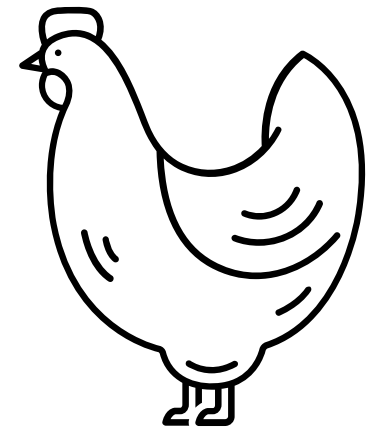
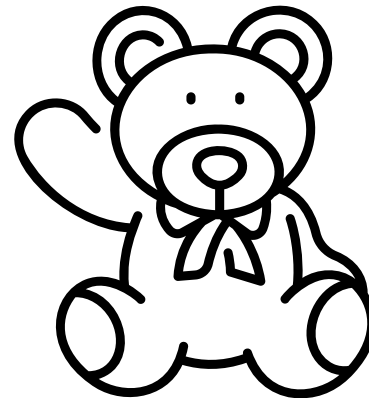
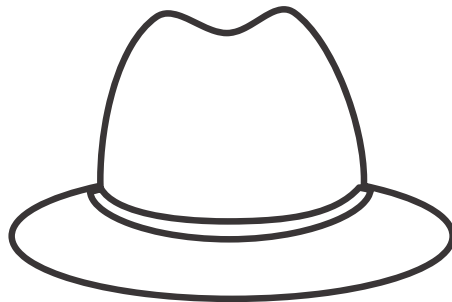
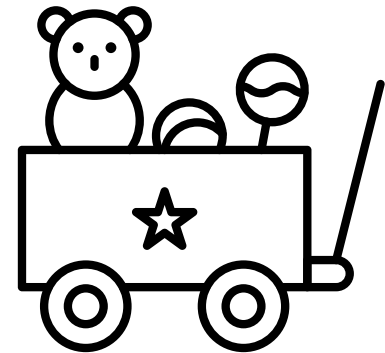
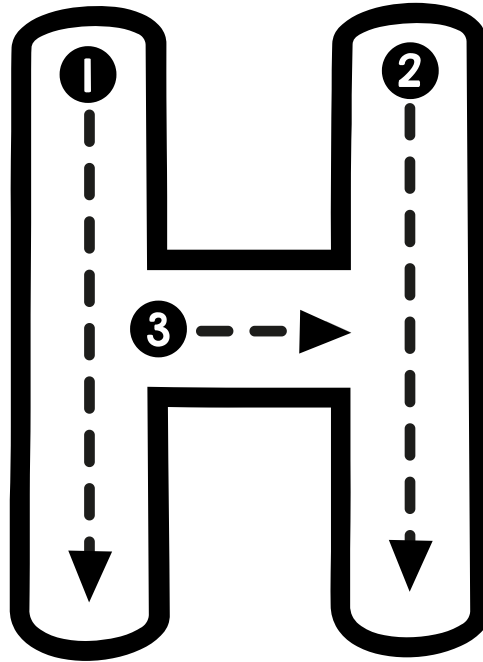
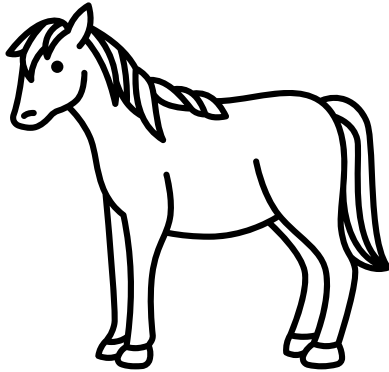

**Color the pictures that begin with the
sound of the letter I**

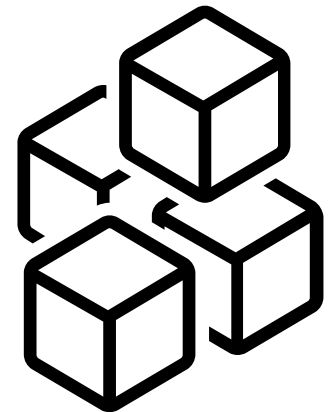
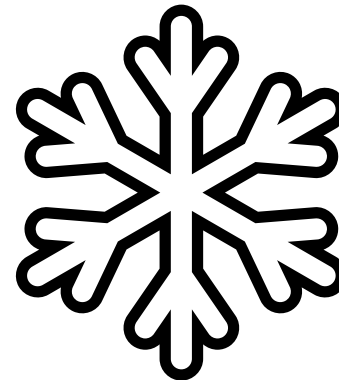
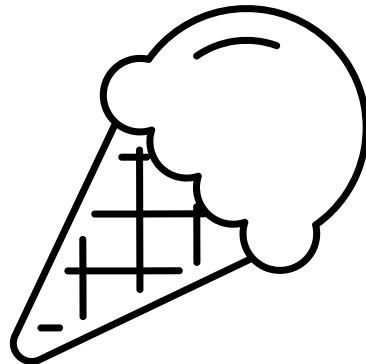
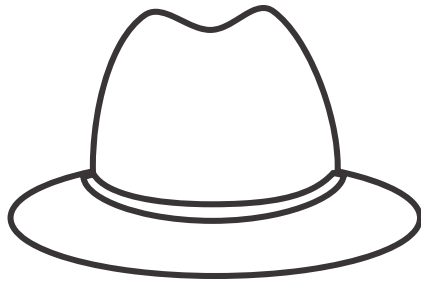
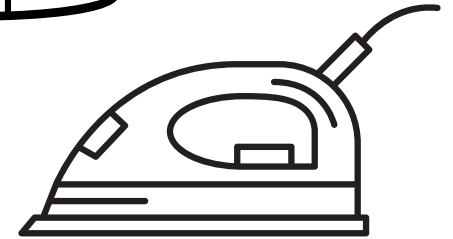
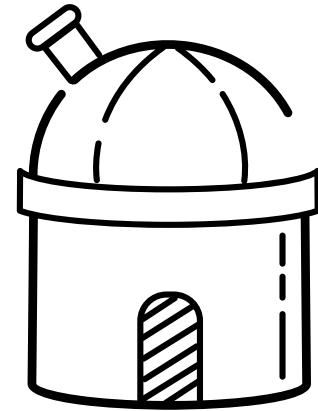
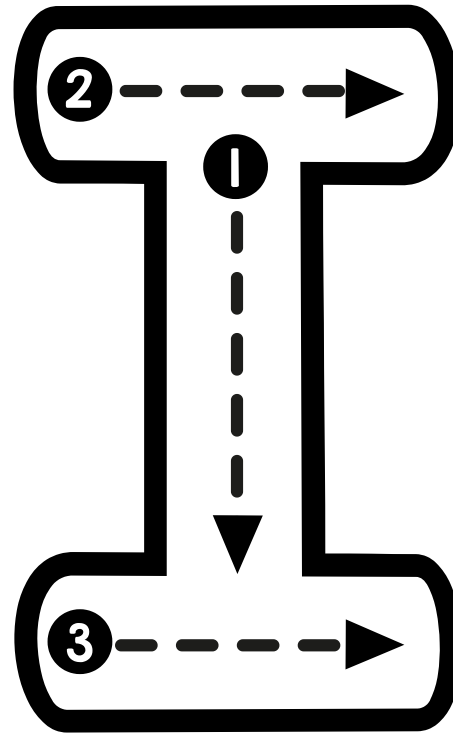
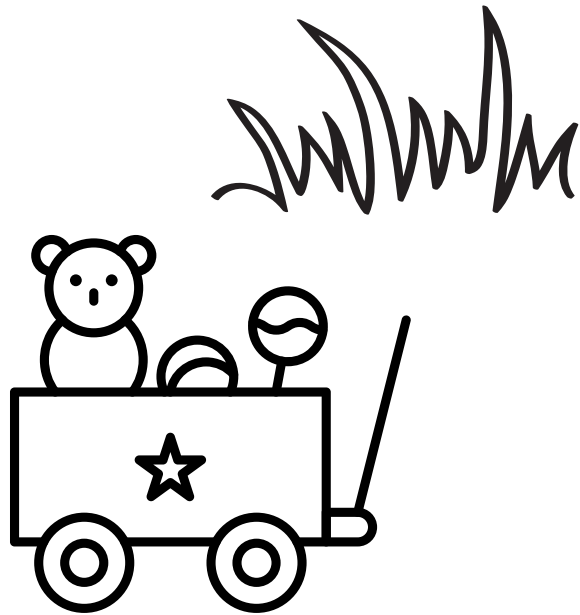

**Color the pictures that begin with the
sound of the letter J**

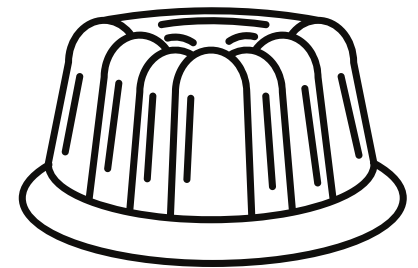
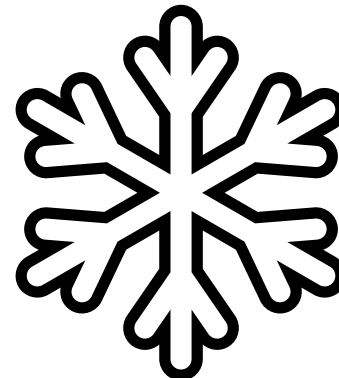
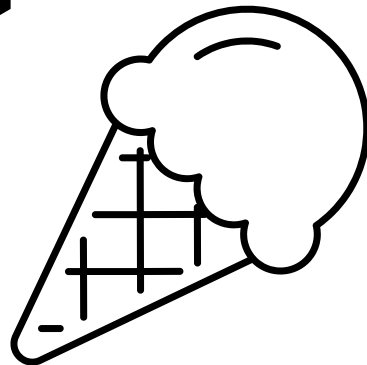
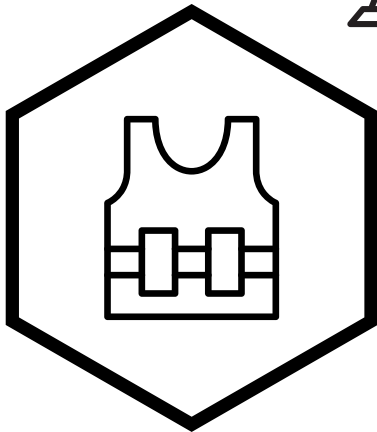
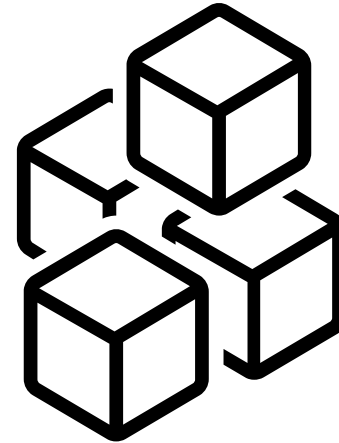
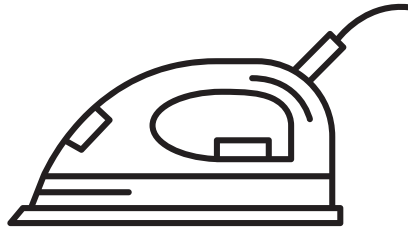
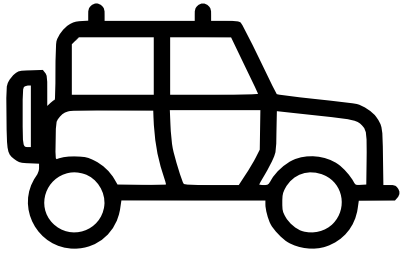

**Color the pictures that begin with the
sound of the letter K**

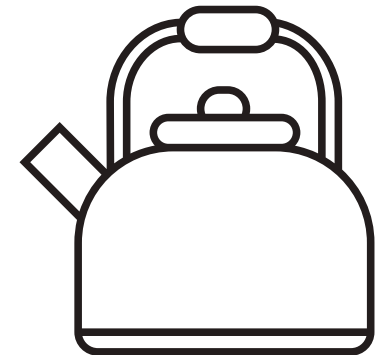
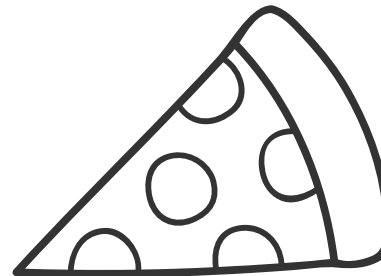
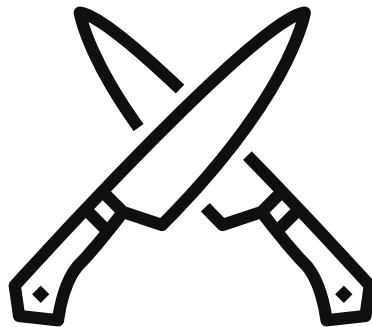
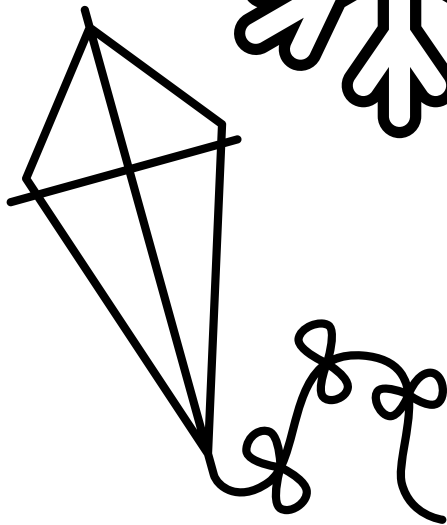
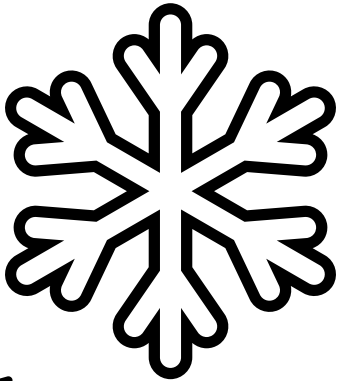
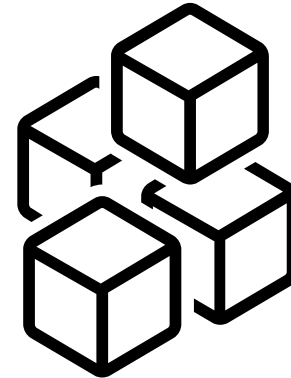
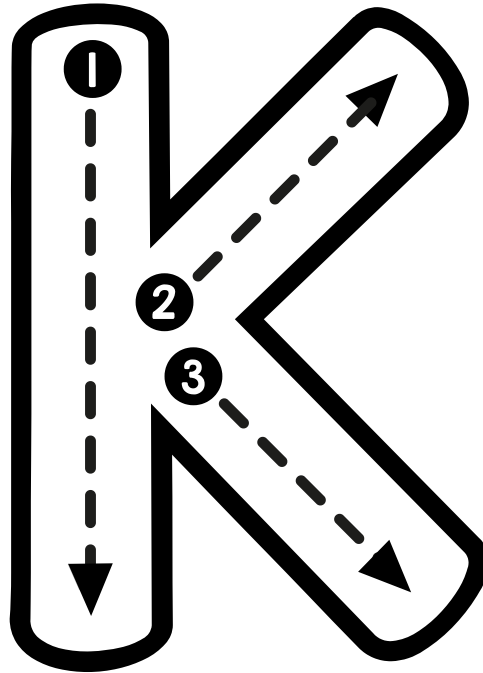
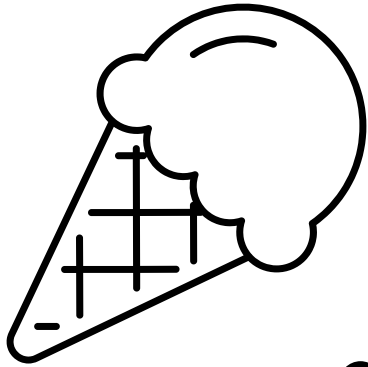

**Color the pictures that begin with the
sound of the letter L**

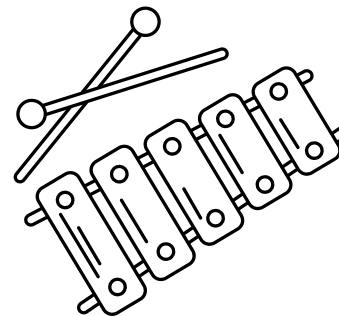
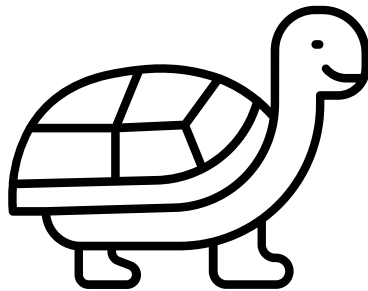
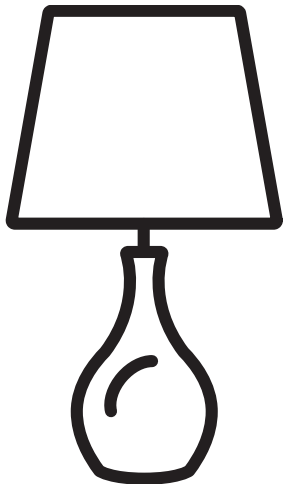
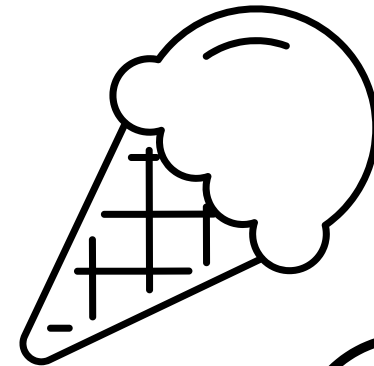
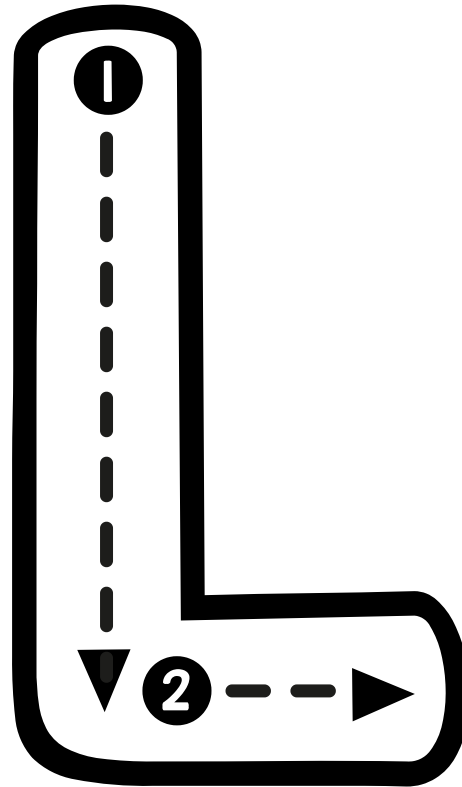
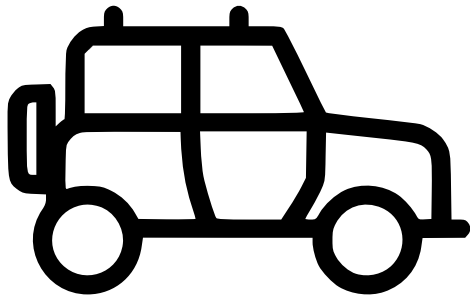
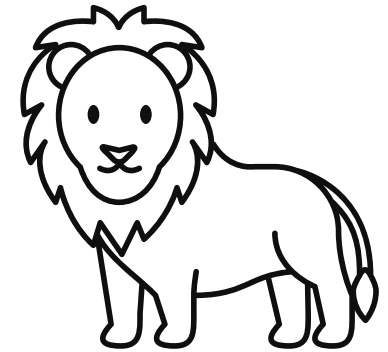
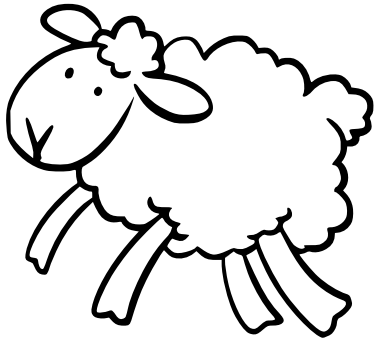

**Color the pictures that begin with the
sound of the letter M**

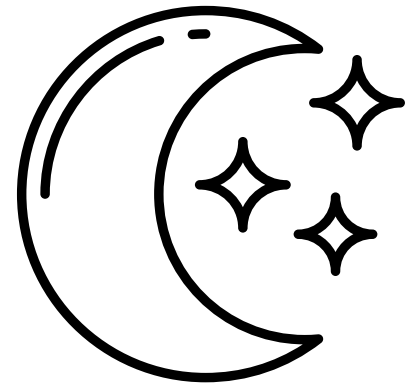
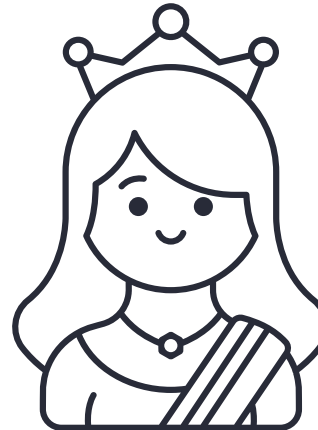
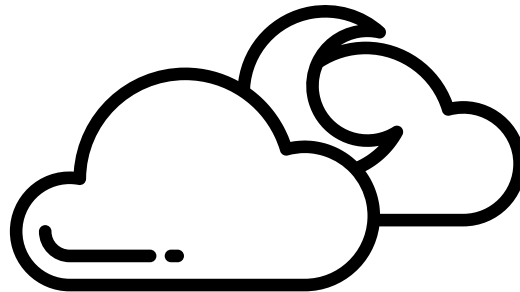
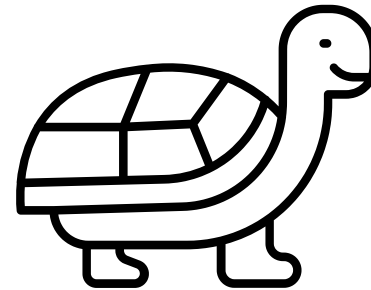
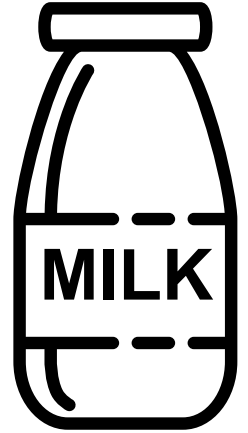
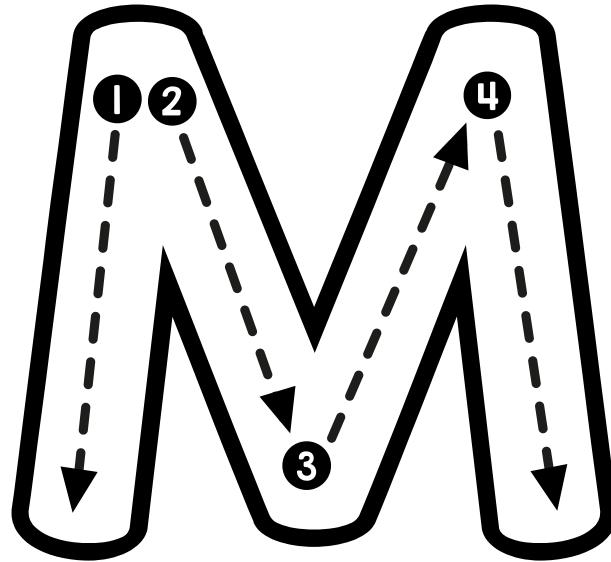
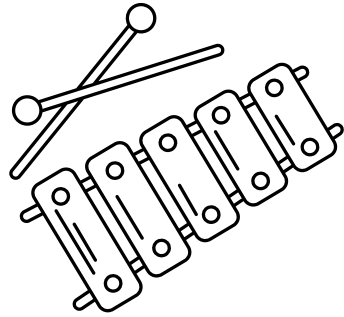
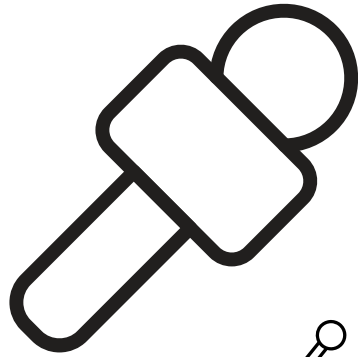

Color the pictures that begin with the
sound of the letter N

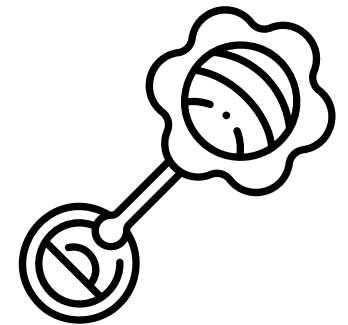
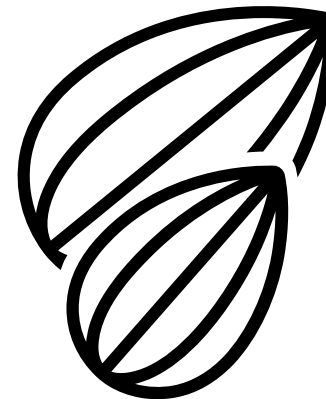
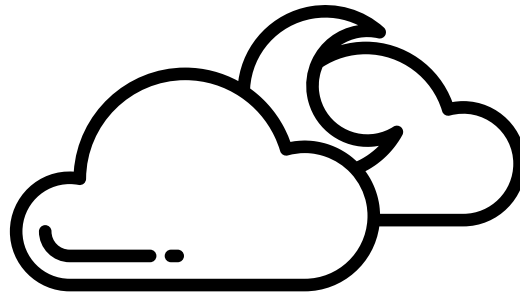
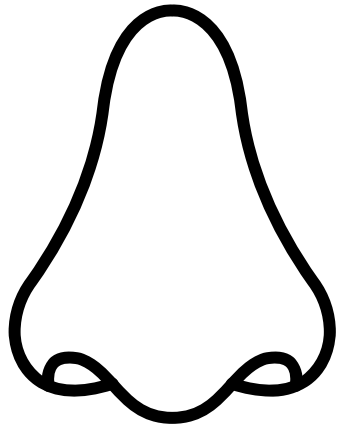
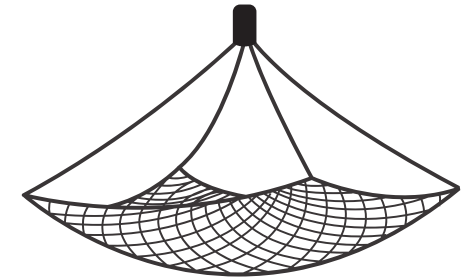
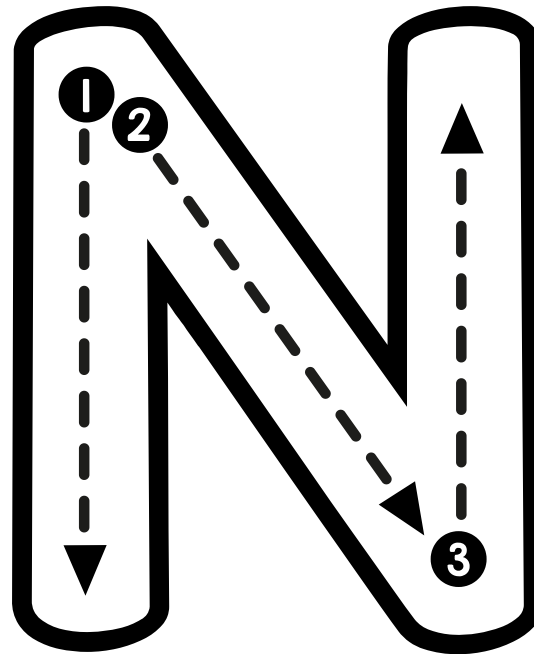
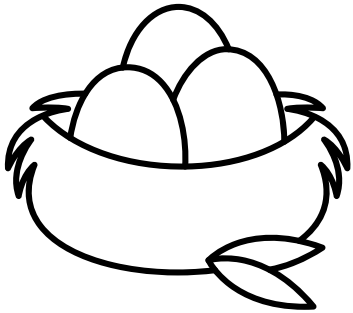

**Color the pictures that begin with the
sound of the letter O**

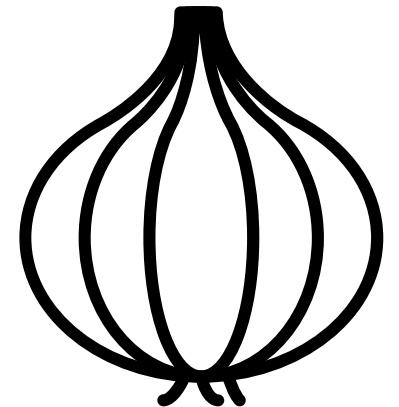
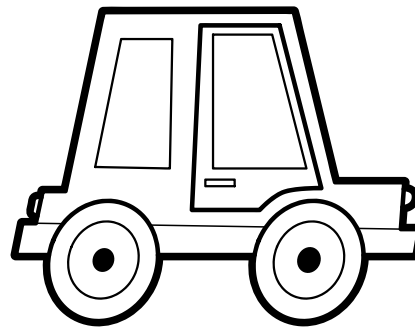
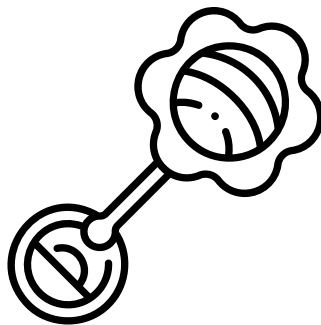
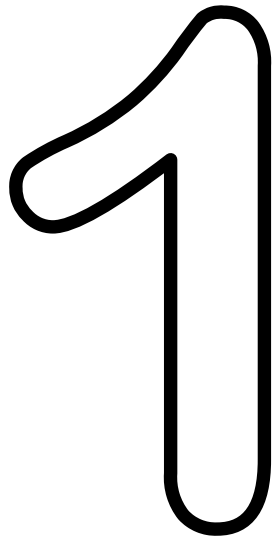
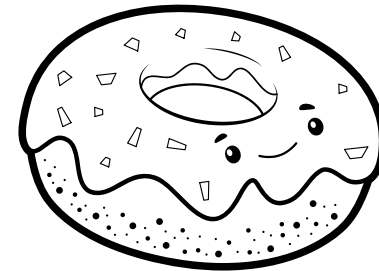
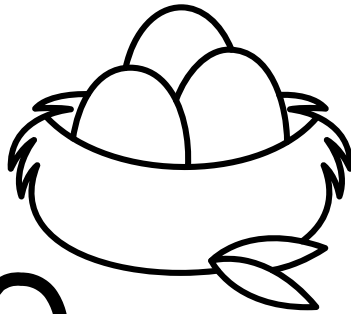
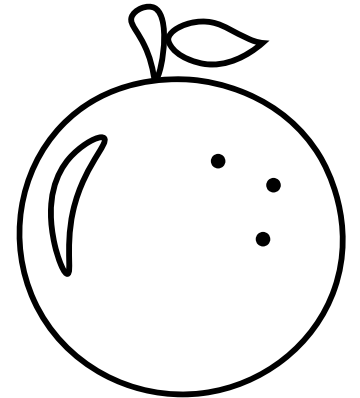
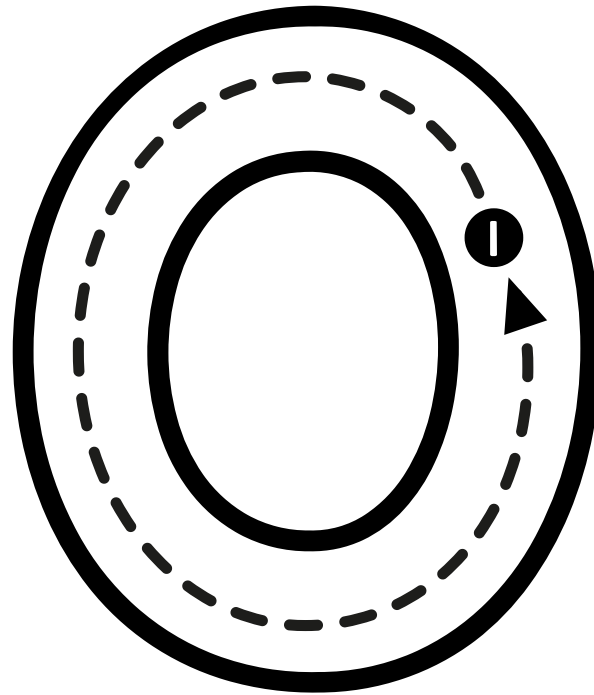
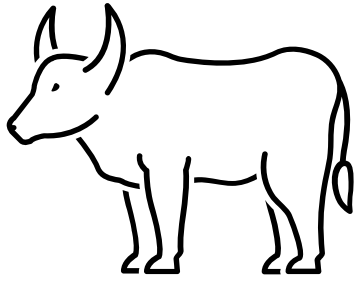

Color the pictures that begin with the
sound of the letter P

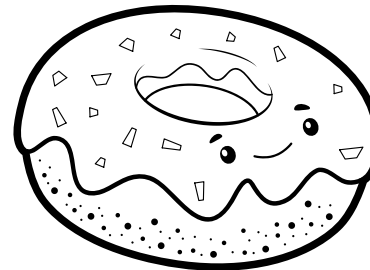
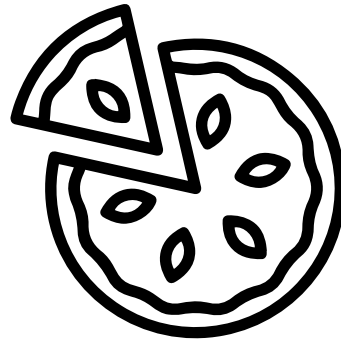
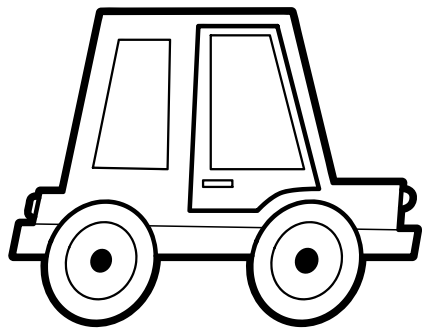
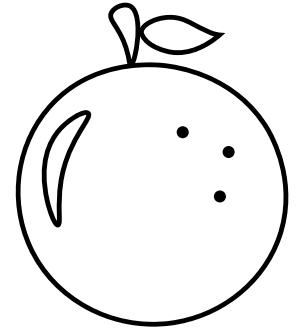
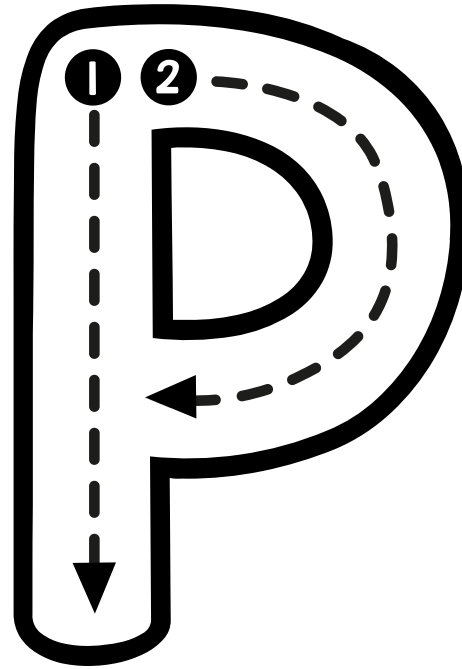
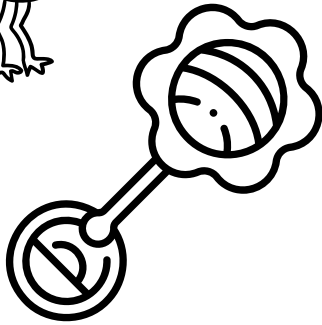
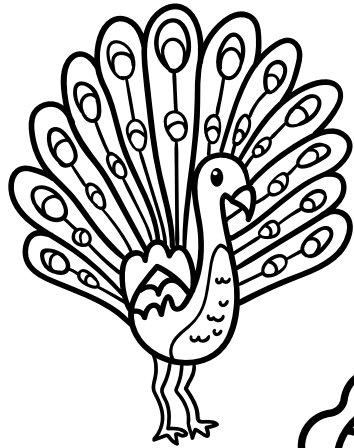

Color the pictures that begin with the
sound of the letter Q,

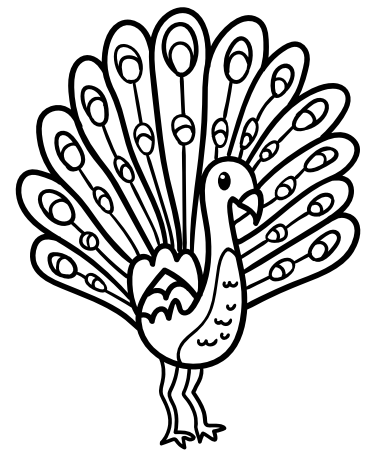
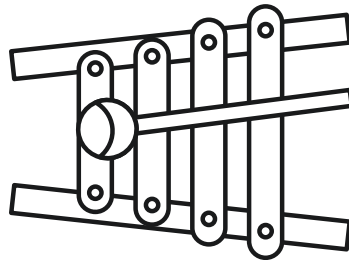
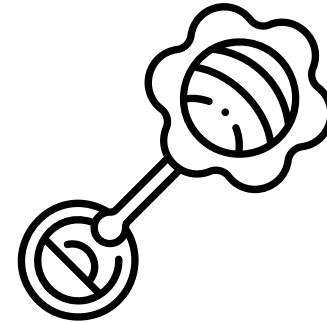
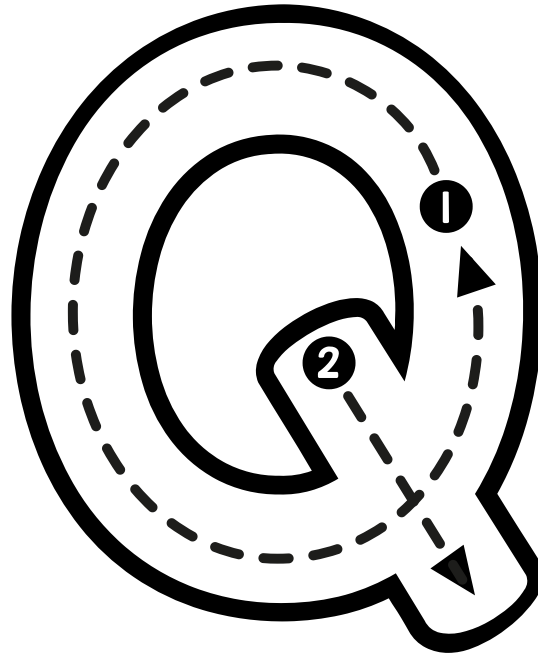
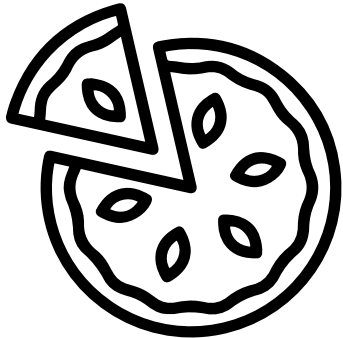
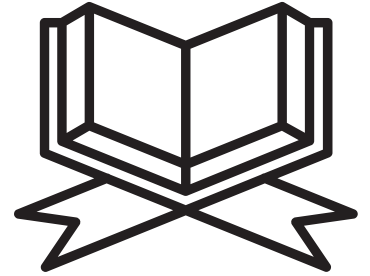
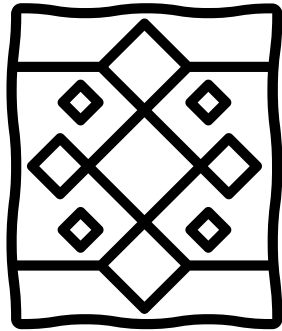

**Color the pictures that begin with the
sound of the letter R**

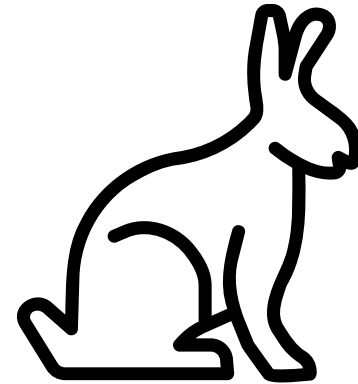
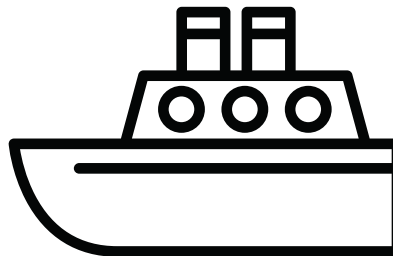
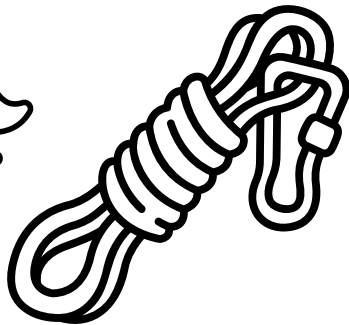
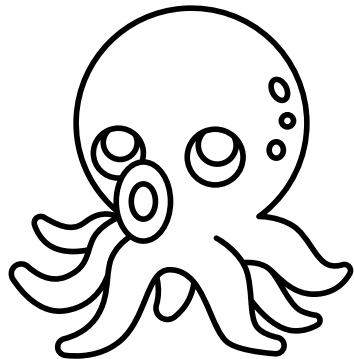
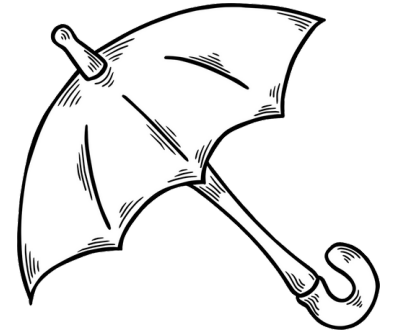
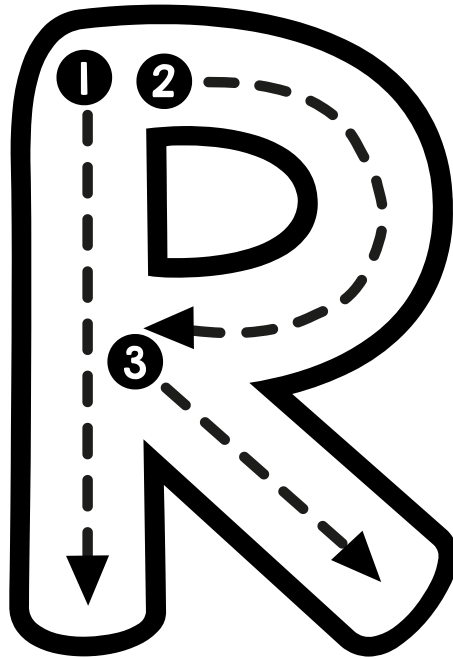
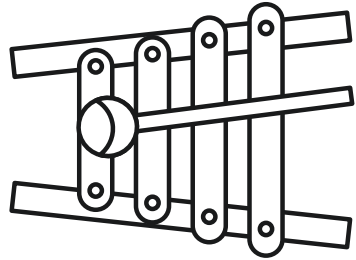

**Color the pictures that begin with the
sound of the letter S**

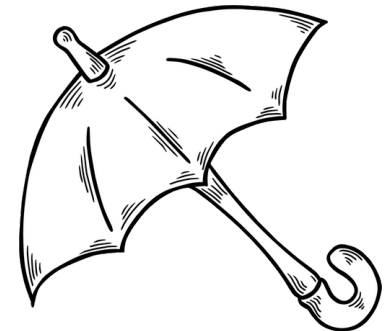
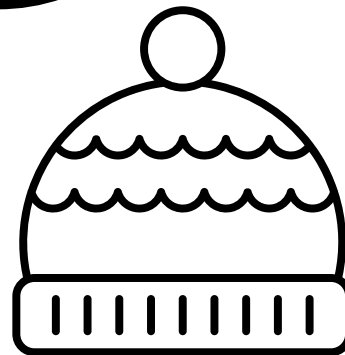
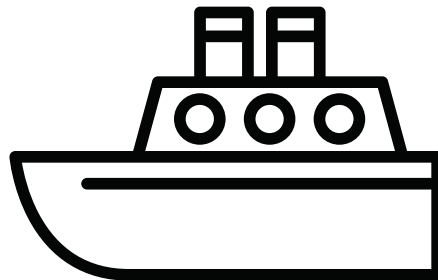
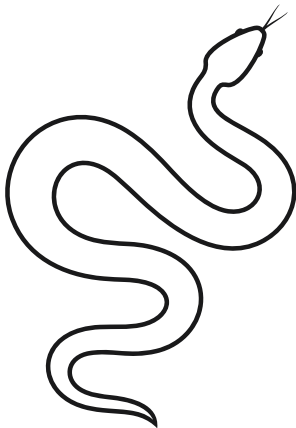
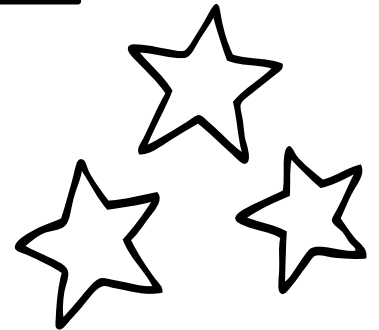
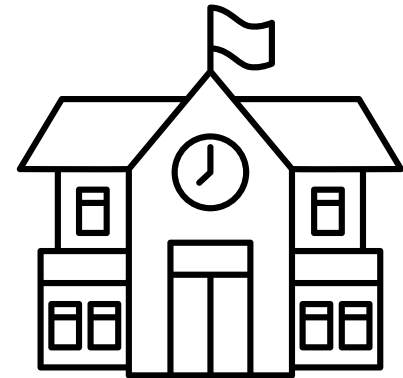
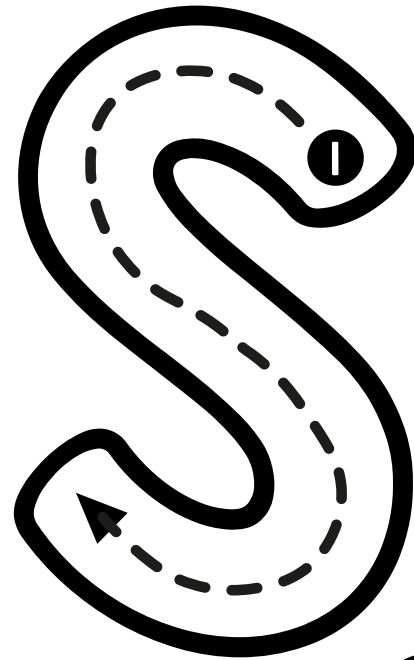
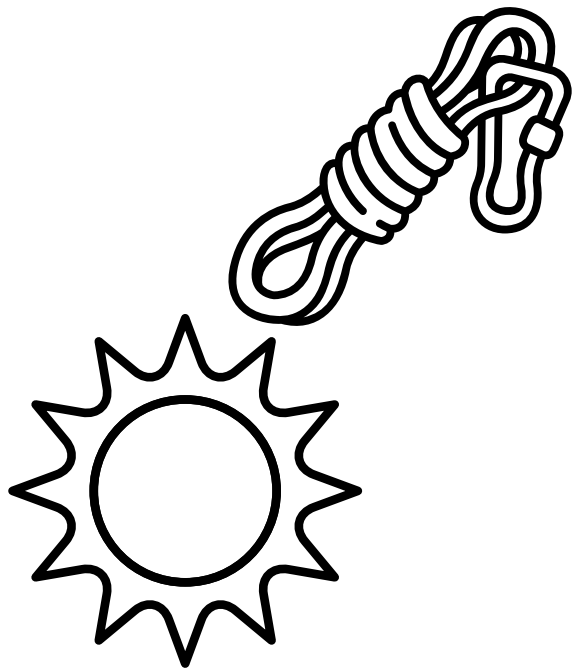

**Color the pictures that begin with the
sound of the letter T**

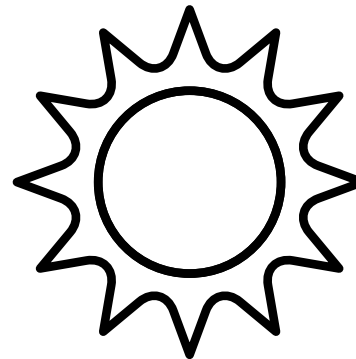
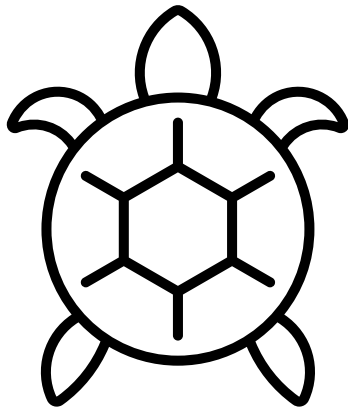
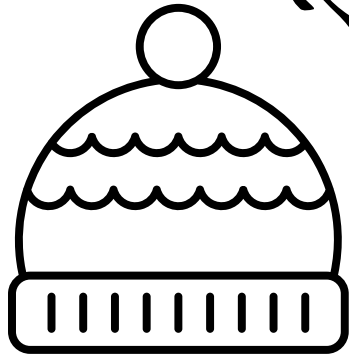
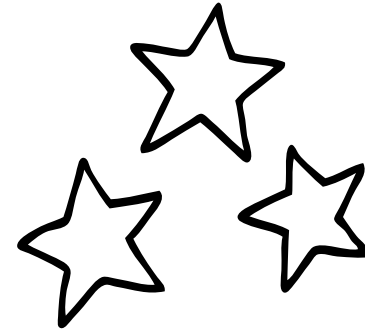
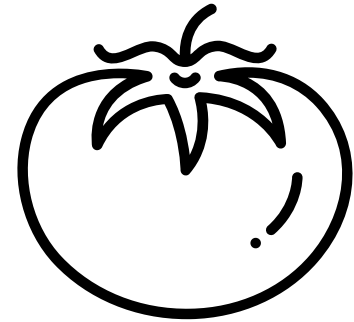
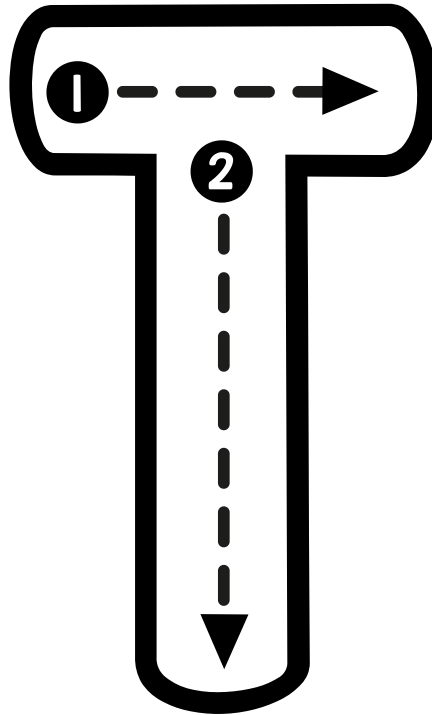

**Color the pictures that begin with the
sound of the letter U**

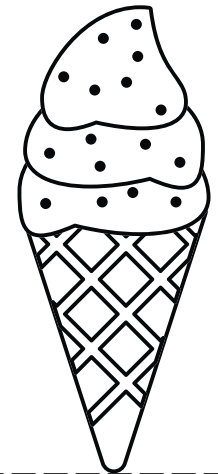
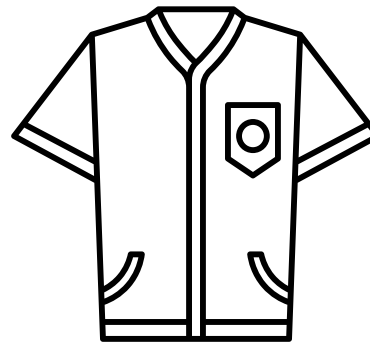
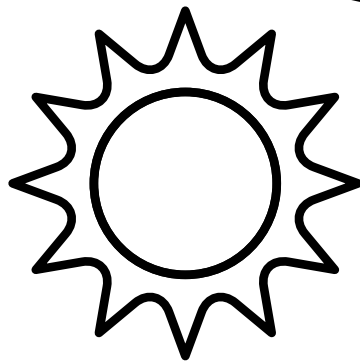
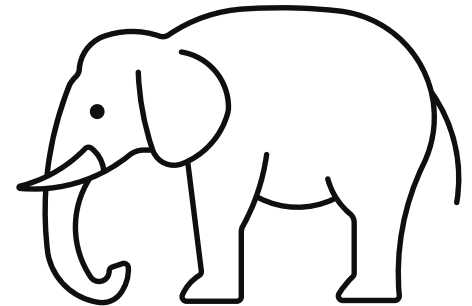
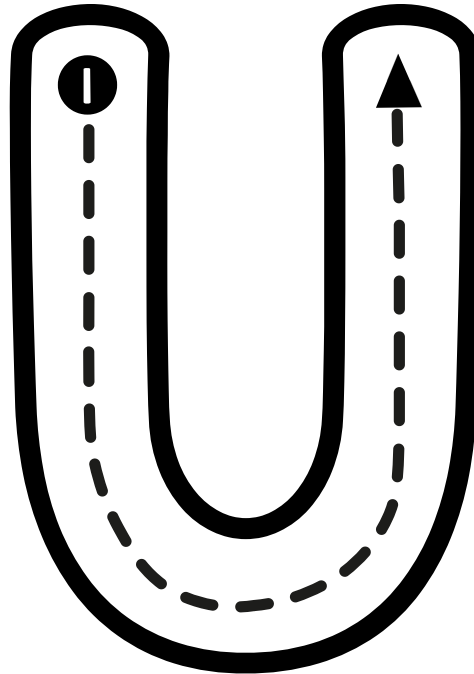
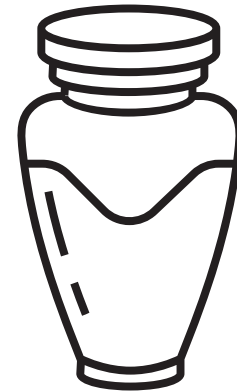
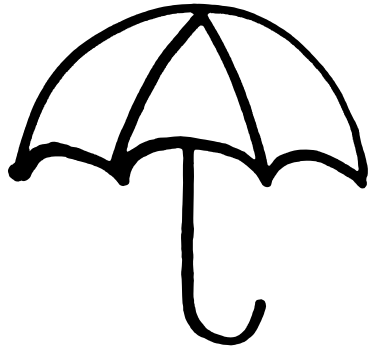

**Color the pictures that begin with the
sound of the letter V**

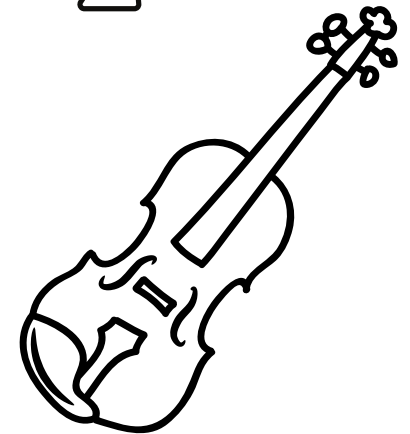
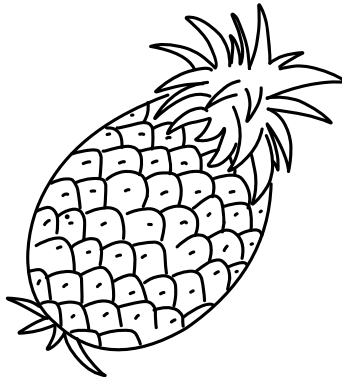
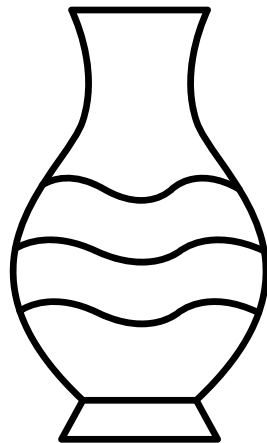
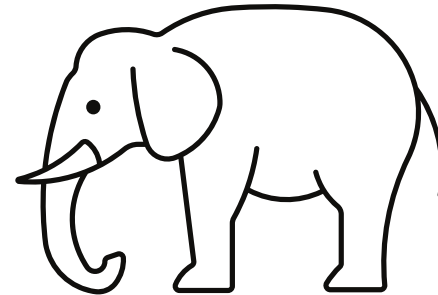
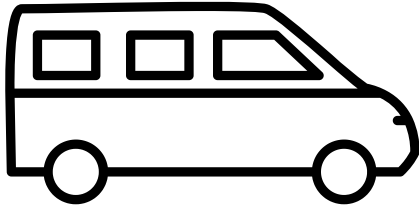
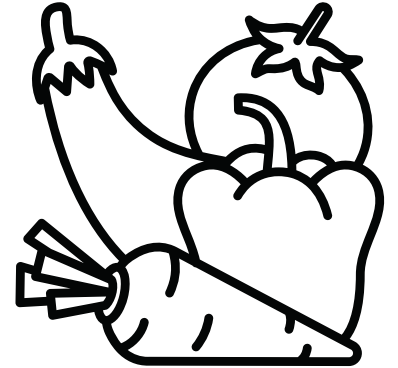
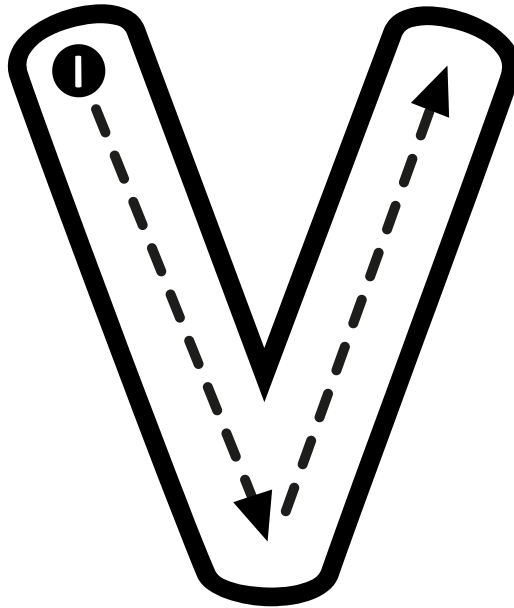
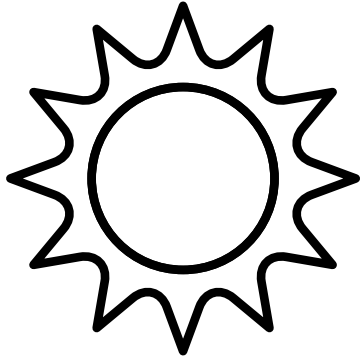

**Color the pictures that begin with the
sound of the letter W**

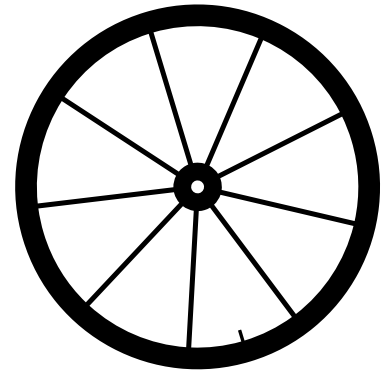
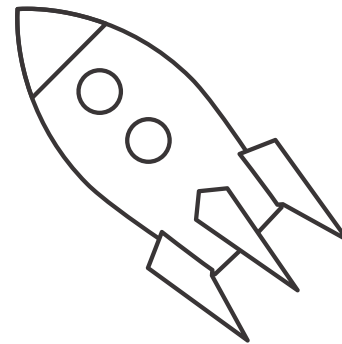
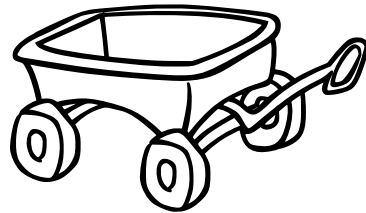
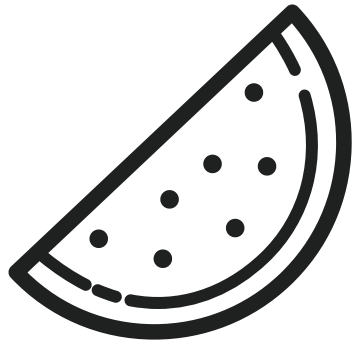
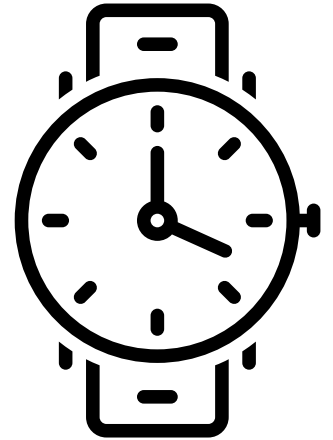
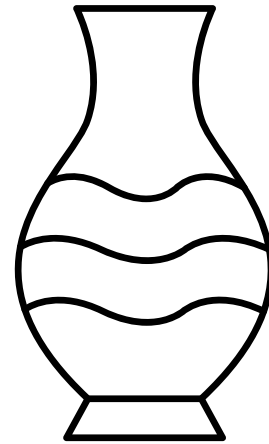
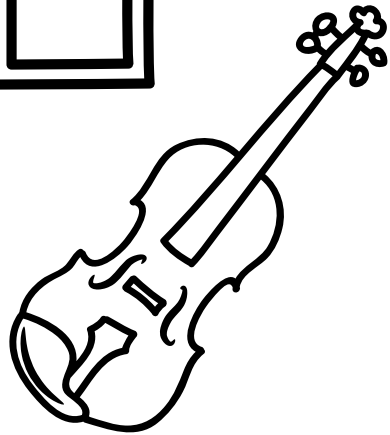
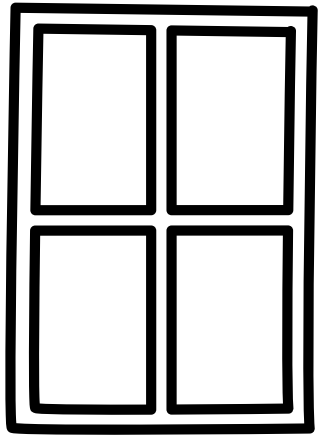

**Color the pictures that begin with the
sound of the letter X**

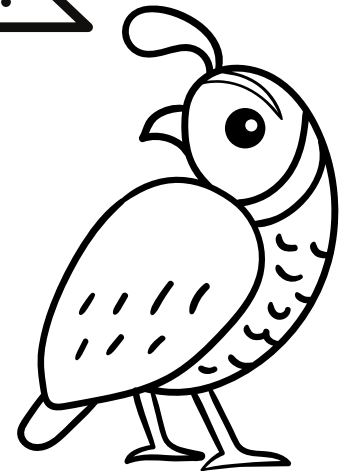
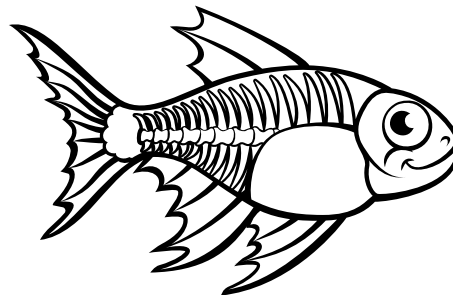
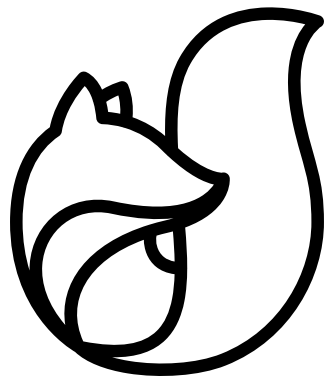
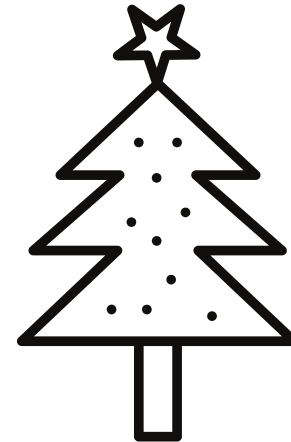
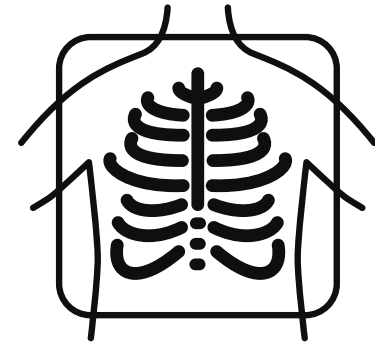
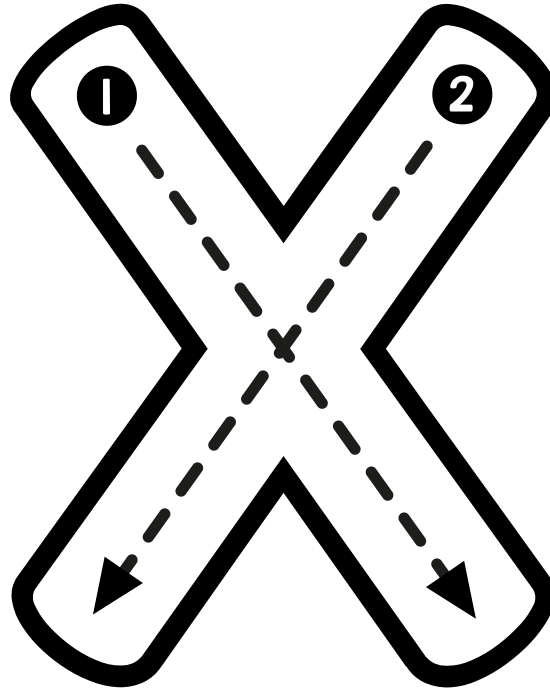
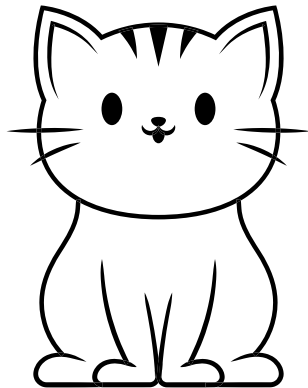
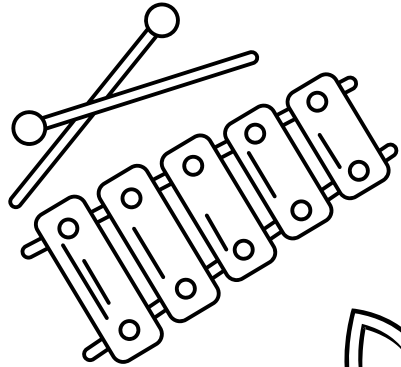

**Color the pictures that begin with the
sound of the letter Y**

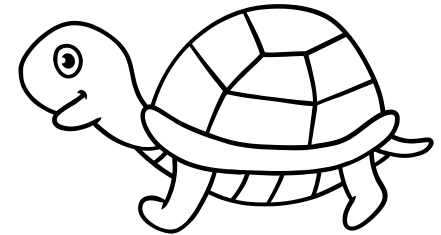
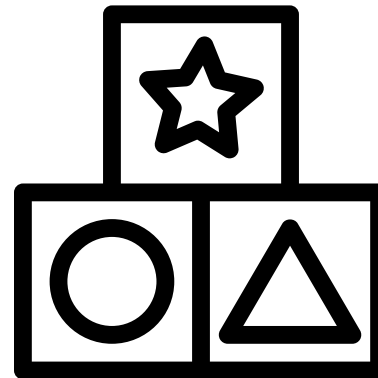
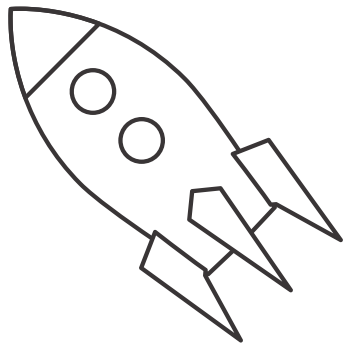
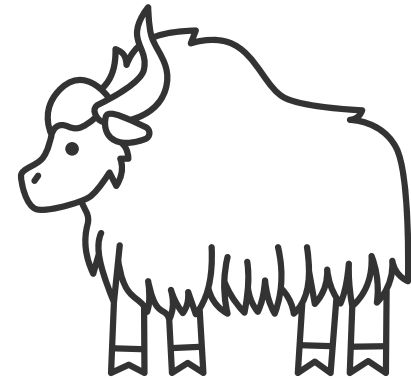
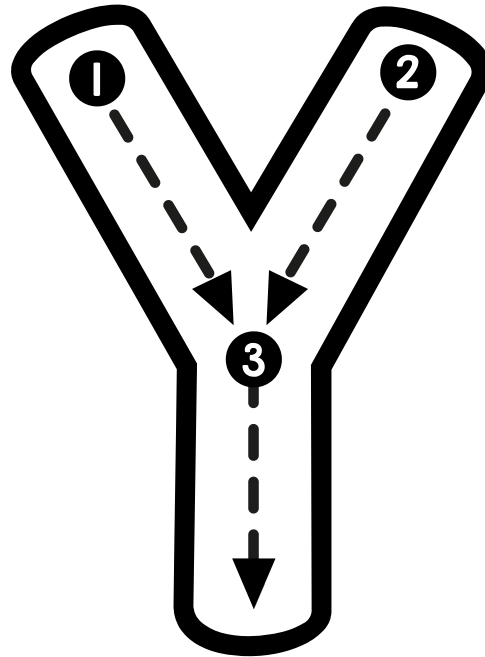
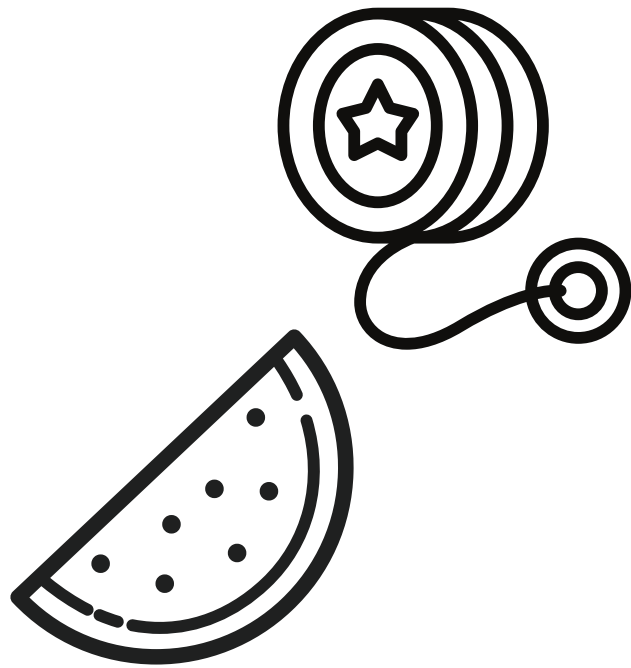

Color the pictures that begin with the
sound of the letter Z

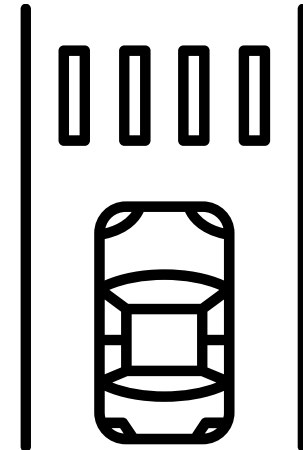
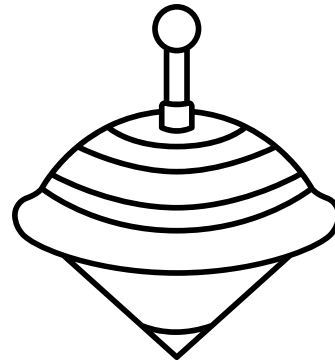
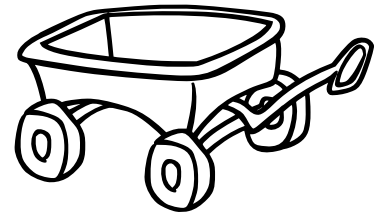
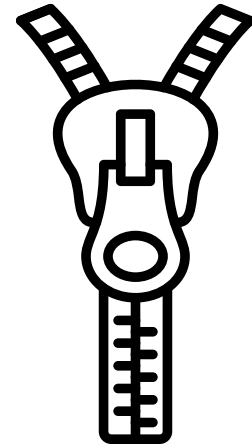
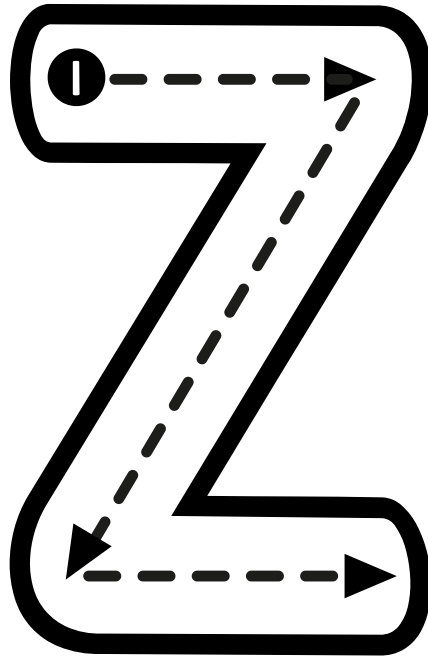
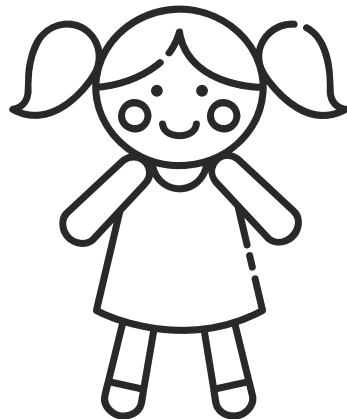
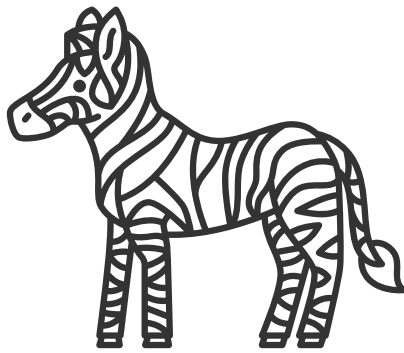
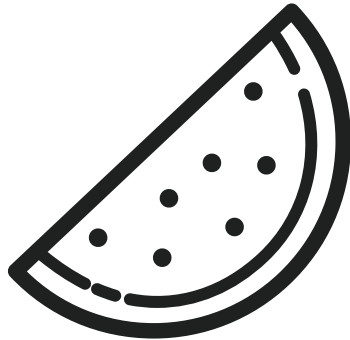
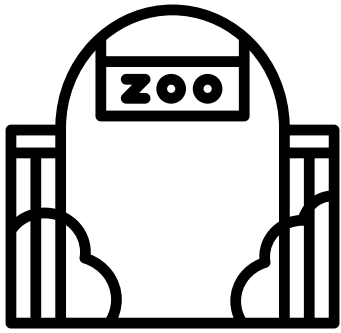

What is the begining sound ? color it

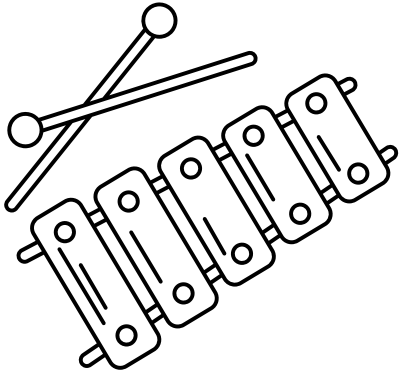

X

V

H



F

B

U

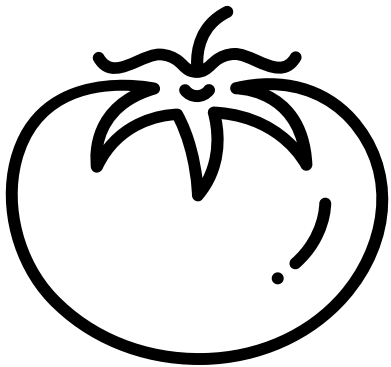

K

T

L

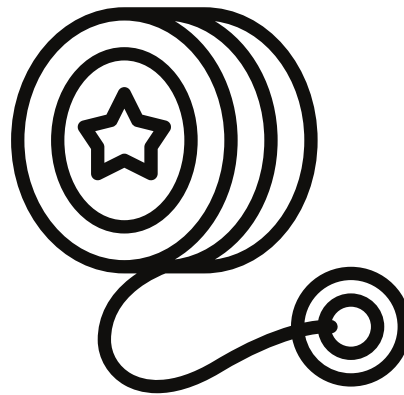

R

Y

O

What is the begining sound ? color it

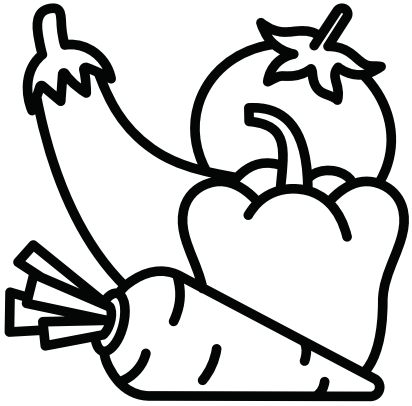

G

V

H



I

B

F



M

I

L

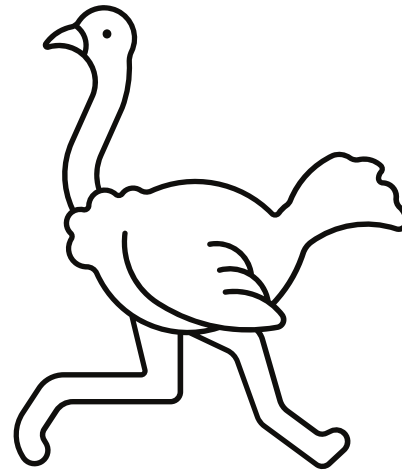

R

O

W

What is the begining sound ? color it

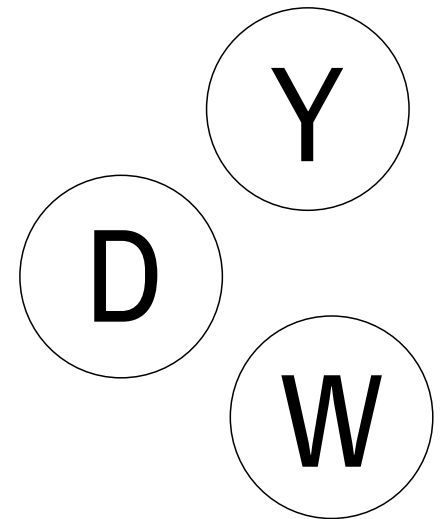
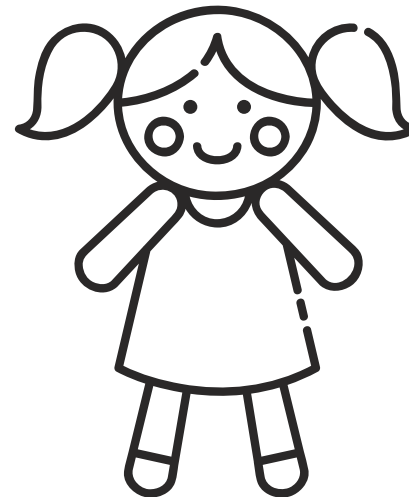
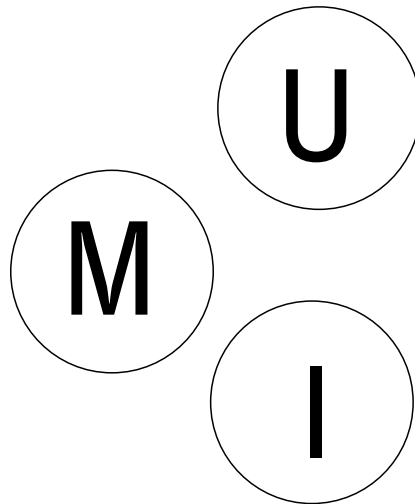
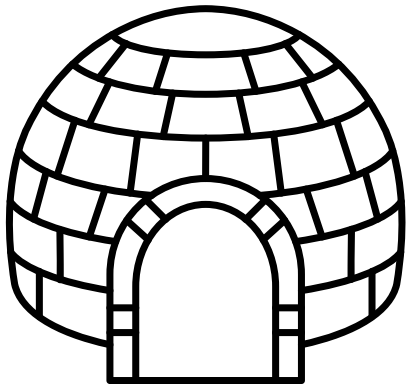
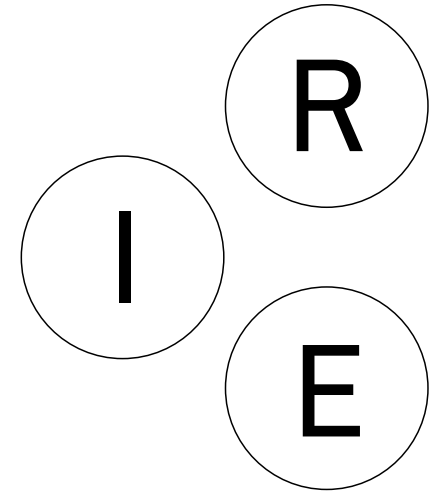
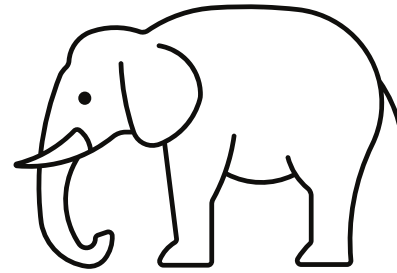
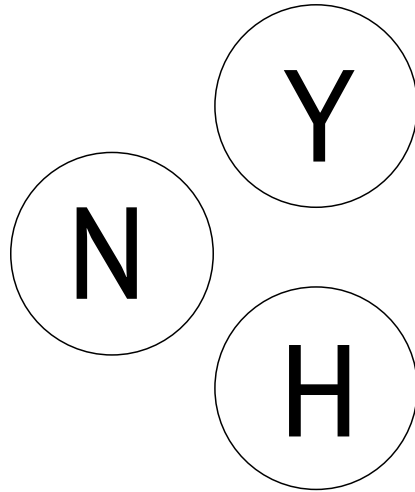

What's The Letter ?

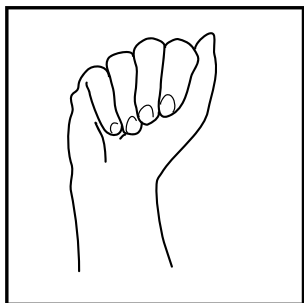

=

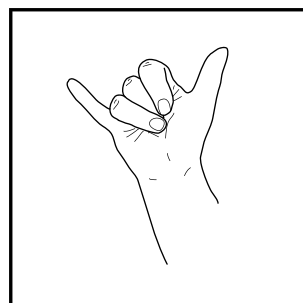
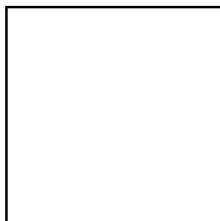

=

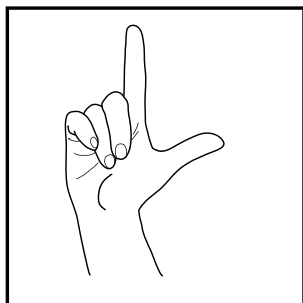
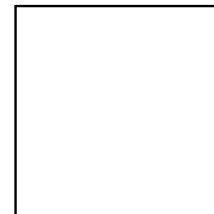

=

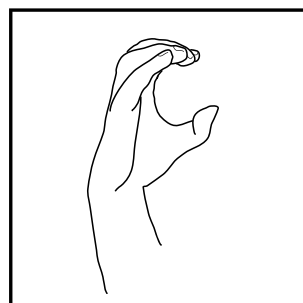
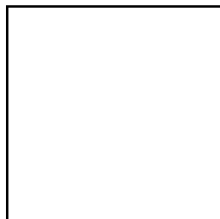

=

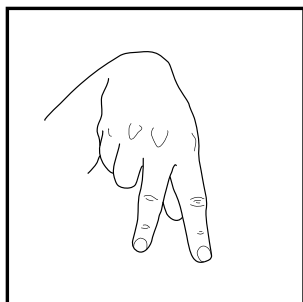
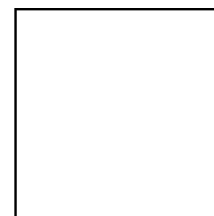

=

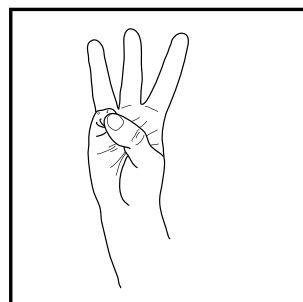

=

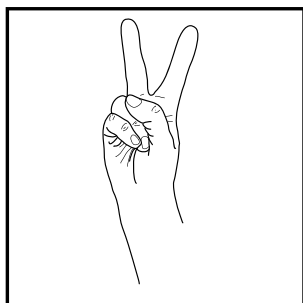
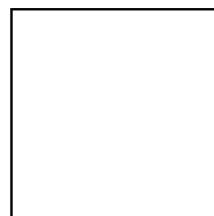

=

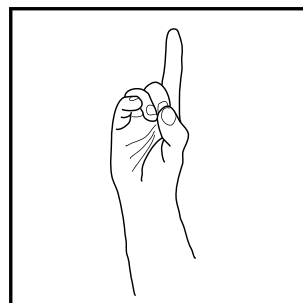
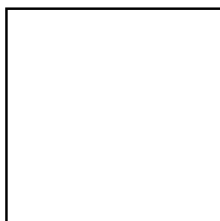

=

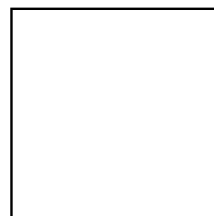

What's The Letter ?

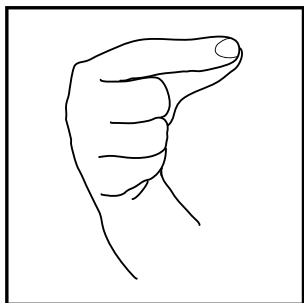

=

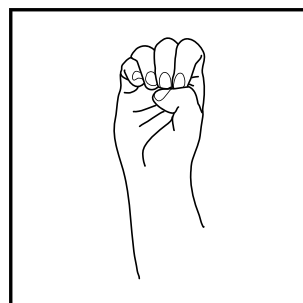
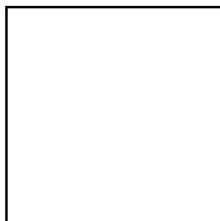

=

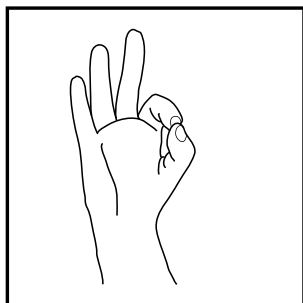
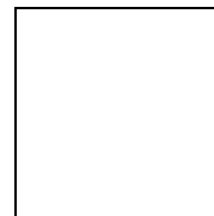

=

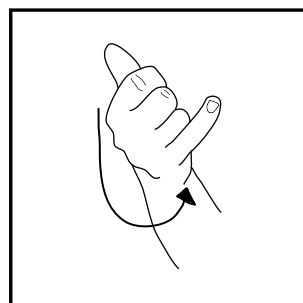
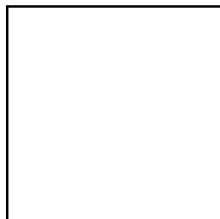

=

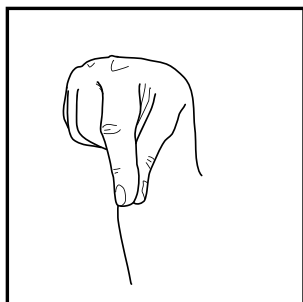
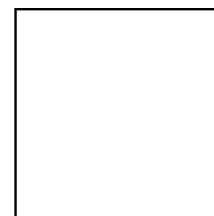

=

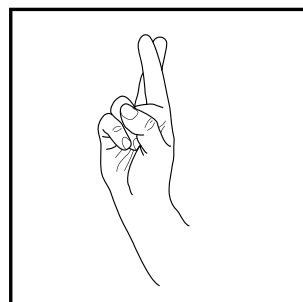

=

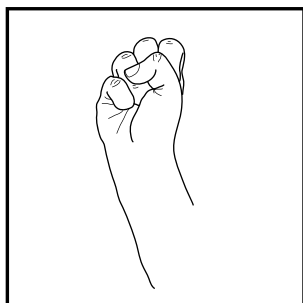
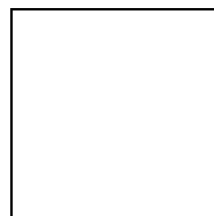

=

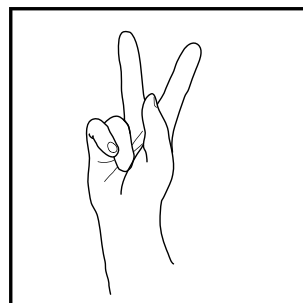
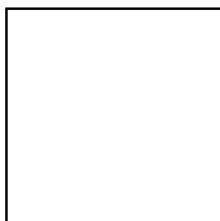

=

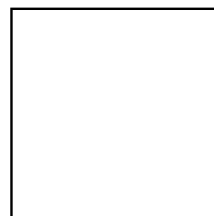

What's The Letter ?

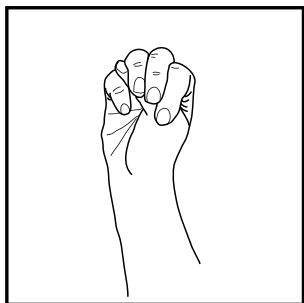

=

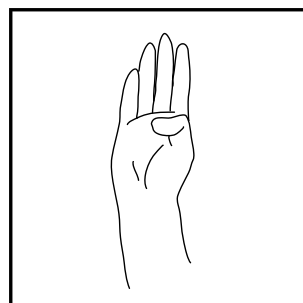
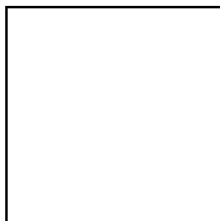

=

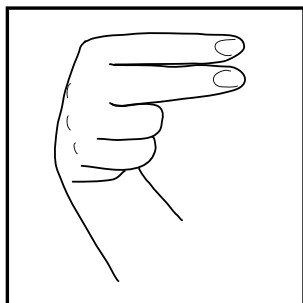
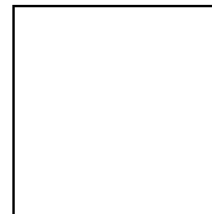

=

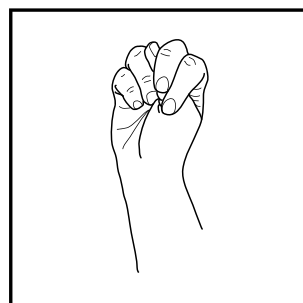
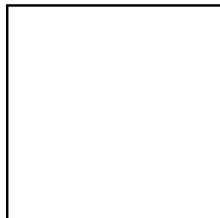

=

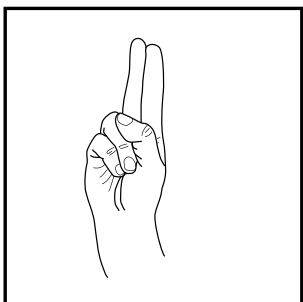
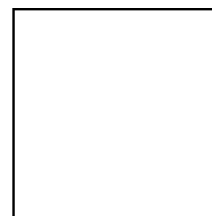

=

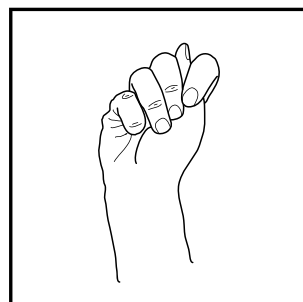

=

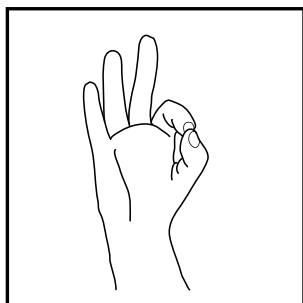
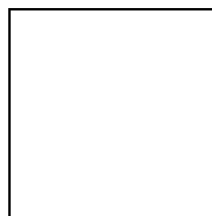

=

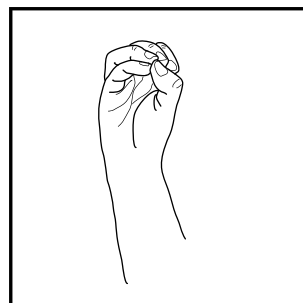
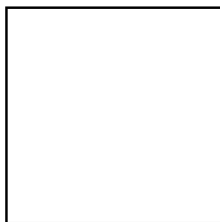

=

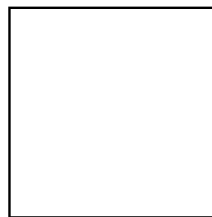

What starts with CH ?

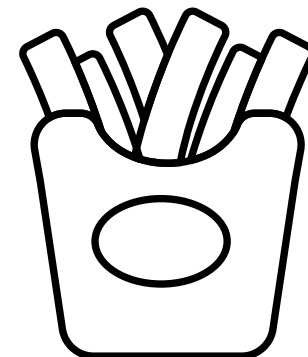
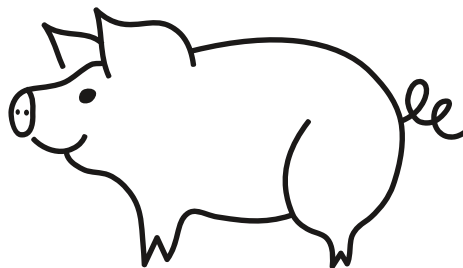
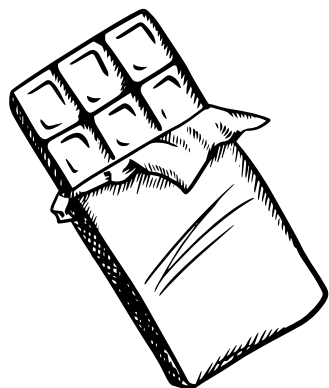
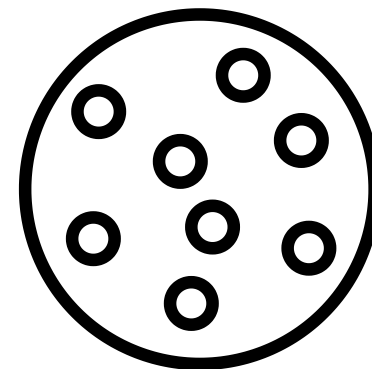
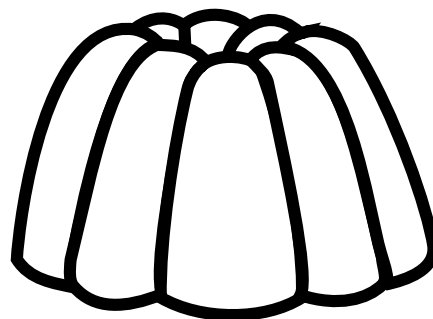
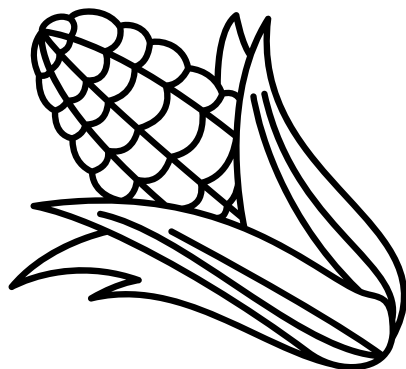
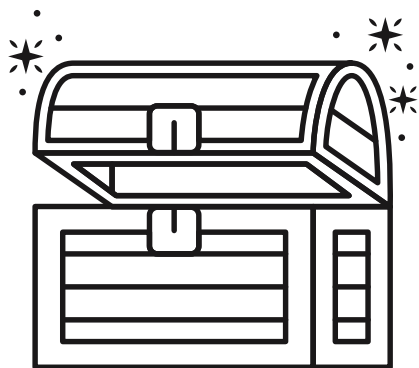
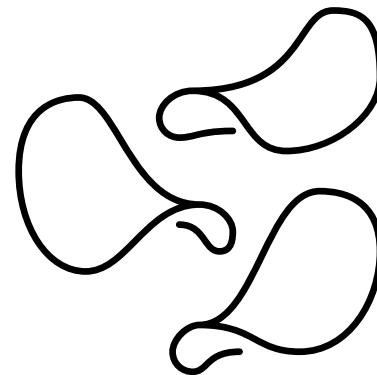
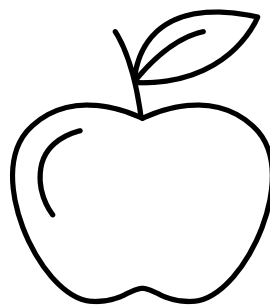
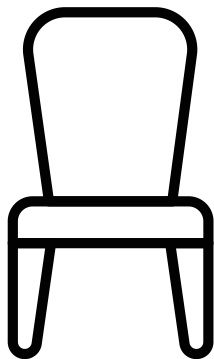

What starts with SH ?

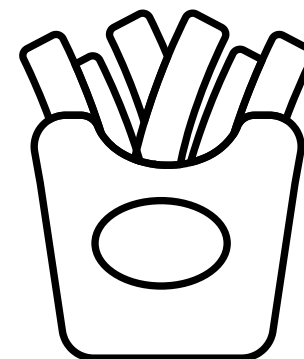
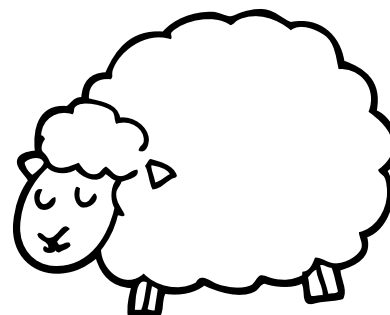
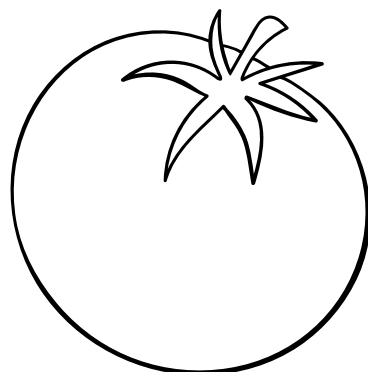
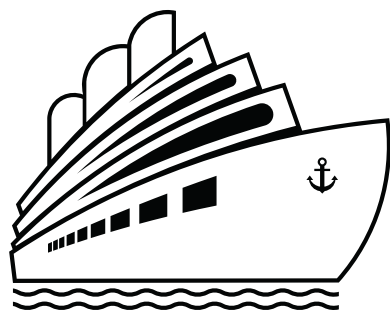
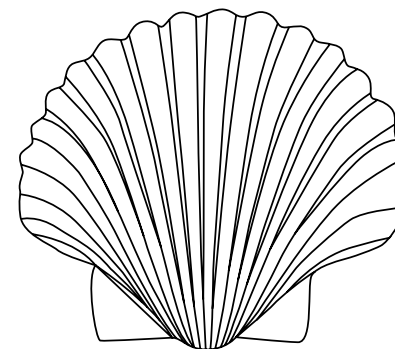
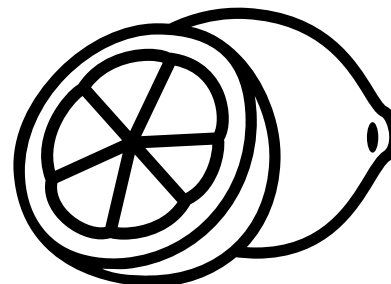
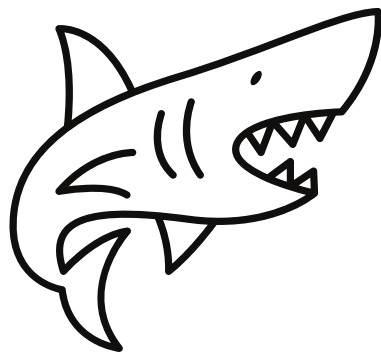
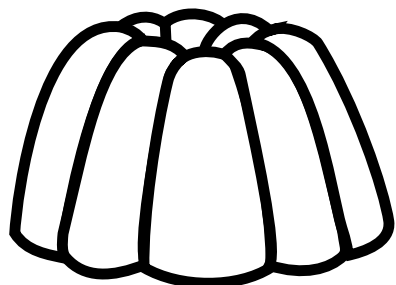
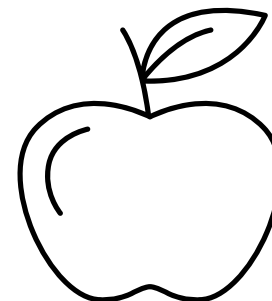
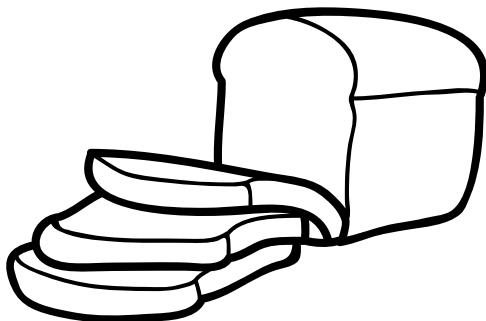

What starts with TH ?

